

PRATT

SAFETY SYSTEMS

BY PIP

ENVIRONMENTAL AND SITE SAFETY SOLUTIONS



ABOUT **PRATT SAFETY**

FOR OVER 40 YEARS, PRATT SAFETY SYSTEMS HAS BEEN SUPPLYING INDUSTRIES IN AUSTRALIA, NEW ZEALAND AND ACROSS THE GLOBE.

WITH QUALITY SITE SAFETY & ENVIRONMENTAL PROTECTION PRODUCTS THAT COMPLY WITH AS/NZS AND INTERNATIONAL STANDARDS, OUR RANGE OF PRODUCTS ARE ROBUST ENOUGH FOR ANY WORKING ENVIRONMENT IN THE WORLD

Pratt is proud to provide a comprehensive range of products consisting of emergency showers & eye washes, dangerous goods storage cabinets, gas cages, spill containment & spill kits.

With an ever increasing focus on workplace & environmental safety, Pratt Safety Systems is committed to on going product development to ensure our customers have access to the latest technology available.

INITIATIVES:

- Introduced Safety Showers to Australian Market in 1968
- Introduced Safety Cabinets and Cans into Australian Market in 1981

With over 70-years combined experience in the safety industry, rarely have our team come across an issue or occurrence that we have not tackled previously. From being integral members of national safety councils, to advising on standards and regulations within the industry, our staff have done it all. With this knowledge, all customers can have the confidence that the advice and recommendations they receive from a member of our expert team is truly of a high-class standard.

SCAN THE QR CODES THROUGHOUT THE CATALOGUE TO VIEW AND DOWNLOAD PRODUCT DATA SHEETS.

HOW TO SCAN A QR CODE

- 1. OPEN YOUR PHONE CAMERA**
- 2. POINT YOUR CAMERA AT THE QR CODE**
- 3. TAP THE POP UP NOTIFICATION**



**WHEN PERFORMANCE
IS PARAMOUNT.....
THINK PRATT**

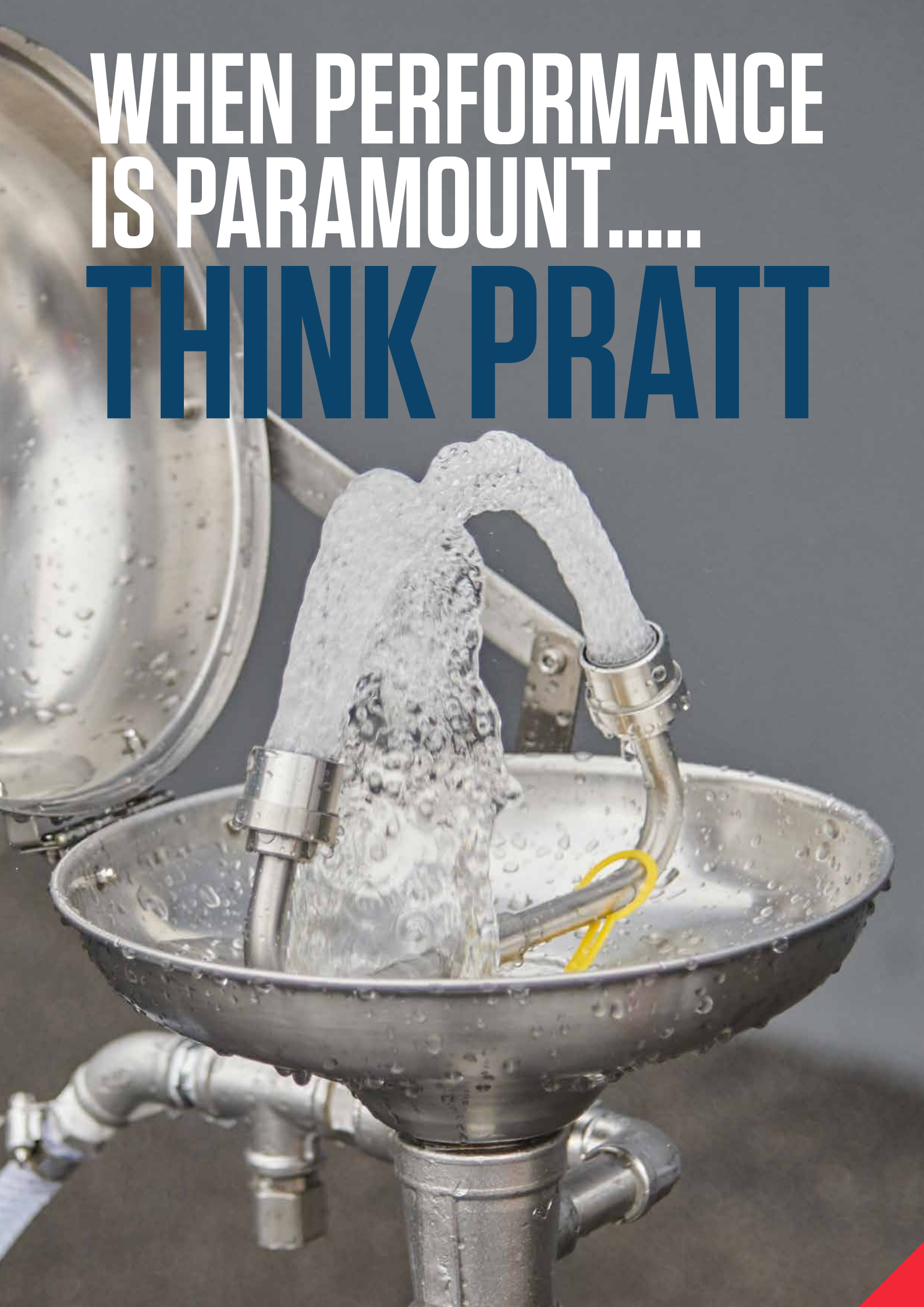

EMERGENCY SHOWERS & EYE WASH UNITS

- EMERGENCY SHOWERS & COMBINATION UNITS
 - EYEWASH UNITS
 - LABORATORY UNITS
 - PORTABLE EYEWASH UNITS
-

PRATT HAVE BEEN THE PIONEERS OF SAFETY SHOWERS FOR OVER 40 YEARS. PRATT SAFETY SYSTEMS CAN PROVIDE YOU WITH STRONG AND RELIABLE EQUIPMENT FOR ANY WORKPLACE REQUIREMENTS. YOU HAVE A PEACE OF MIND KNOWING THAT YOU'RE PROVIDING YOUR EMPLOYEES WITH THE BEST IN INITIAL FIRST AID TREATMENT FOR CHEMICAL BURNS AND INJURIES.

ALL PRATT EMERGENCY SHOWERS AND EYE WASH STATIONS ARE DESIGNED AND MANUFACTURED IN ISO9001 ACCREDITED FACILITY WITH FULL CONFORMANCE TO AS4775 AND AMERICAN ANSI Z358.1 STANDARDS.

With the ever increasing focus on workplace and environmental safety, Pratt Safety Systems has the knowledge and expertise to find solutions to any of our customers' needs, and we are committed to ongoing product development to ensure our customers have access to the latest technology available.



AEROSTREAM & SWIRLTECH TECHNOLOGY

**DELIVERS WHEN
IT'S NEEDED MOST**



AEROSTREAM

AEROSTREAM technology delivers a gentle cascade of soft flow water to flush away any hazardous materials from the eyes and face. The technology allows the user greater comfort at a time when its needed most. All the eye wash units come standard with (FCR) flow control regulator to ensure effective flow.

SWIRLTECH

SWIRLTECH technology delivers a precise pattern and controlled flow rate of a large volume of flushing fluid, ensuring optimum decontamination when its needed most. All showers come standard with (FCR) flow control regulator, this assists for simultaneous flow between the shower and eyewash to ensure minimum flow outputs aren't compromised.



EMERGENCY COMBINATION SHOWER & EYE-FACE WASH UNITS

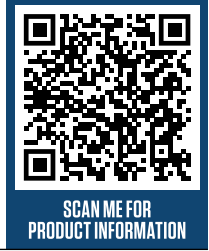

THE CONVENIENCE OF ONE UNIT INCORPORATING BOTH A DELUGE SHOWER AND EYE OR EYE & FACE WASH WITH ONLY ONE WATER SUPPLY CONNECTION REQUIRED.

Available with or without bowl assembly for indoor or outdoor applications, and with or without foot treadle assembly for hand or hand/foot activation for eye washes. All models comply with Australian Standards AS 4775.



SE603

PRATT COMBINATION SHOWER WITH EYE & FACE WASH NOZZLE WITH BOWL. NO FOOT TREADLE



SE607

COMBINATION SHOWER WITH EYE & FACE WASH NOZZLE WITH BOWL & FOOT TREADLE



SE685

COMBINATION SHOWER WITH EYE & FACE WASH NOZZLE NO BOWL. NO FOOT TREADLE



SE689

COMBINATION SHOWER WITH EYE & FACE WASH NOZZLE NO BOWL. WITH FOOT TREADLE



SE607T316

COMBINATION 316SS SHOWER EYE & FACE WASH NOZZLE WITH BOWL & FOOT TREADLE

EMERGENCY COMBINATION SHOWER & EYE WASH UNITS

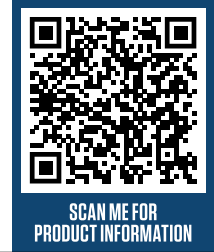

SE612
COMBINATION SHOWER WITH SINGLE NOZZLE EYE
WASH WITH BOWL & FOOT TREADLE



SE616
COMBINATION SHOWER WITH SINGLE NOZZLE EYE
WASH WITH BOWL. NO FOOT TREADLE



SE675
COMBINATION SHOWER WITH SINGLE NOZZLE EYE
WASH NO BOWL. NO FOOT TREADLE



SE679
COMBINATION SHOWER WITH SINGLE NOZZLE EYE
WASH NO BOWL. WITH FOOT TREADLE



SE612T316
COMBINATION 316SS SHOWER SINGLE NOZZLE EYE WASH WITH BOWL & FOOT TREADLE



SE693
COMBINATION 304SS SHOWER WITH SINGLE NOZZLE EYE WASH WITH BOWL & FOOT TREADLE



SE693FTL
COMBINATION SHOWER WITH SINGLE NOZZLE EYE WASH W/ BOWL & TREADLE - FLIP TOP LID

EMERGENCY SHOWERS ONLY

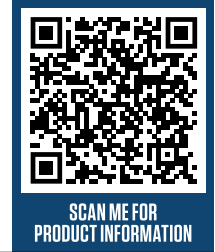

PRATT EMERGENCY SHOWERS RAPIDLY REMOVE CONTAMINANTS FROM THE BODY WITH A DELUGE OF FLUSHING FLUID.

The shower head delivers a large volume flushing fluid spread evenly in a precise pattern and controlled flow rate.

SE253

FREE STANDING SHOWER



SE227

PRATT SHOWER WALL MOUNTED



PORTABLE SHOWER

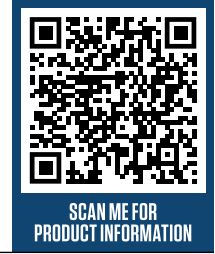

PSPCS

PRATT PORTABLE COLLAPSIBLE DECONTAMINATION SHOWER MULTISPRAY

PEDESTAL EYE WASH & EYE-FACE WASH STATIONS

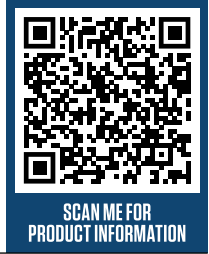

PRATT EYE WASH STATIONS PROVIDE A SOFT FLOWING, SINGLE STREAM OF AERATED FLUID TO THE EYES.

Pratt Eye Wash Stations are available in wall or pedestal mounted units, with or without bowl assembly, and with or without foot treadle activation.



SE420

PRATT PEDESTAL MOUNTED EYE & FACE WASH NOZZLE WITH BOWL NO FOOT TREADLE



SE480

PRATT PEDESTAL MOUNTED EYE & FACE WASH NOZZLE WITH BOWL & FOOT TREADLE



SE584FTL

PRATT PEDESTAL MOUNTED EYEWASH SINGLE NOZZLE WITH BOWL NO TREADLE - FLIP TOP LID



SE545

PRATT PEDESTAL MOUNTED SINGLE NOZZLE EYE WASH WITH BOWL. NO FOOT TREADLE



SE546

PRATT PEDESTAL MOUNTED SINGLE NOZZLE EYE WASH WITH BOWL & FOOT TREADLE



WALL MOUNT EYE WASH & EYE & FACE WASH STATIONS

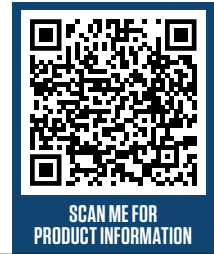

SE400
PRATT WALL MOUNTED EYE & FACE WASH NOZZLE WITH BOWL. NO FOOT TREADLE



SE415
PRATT WALL MOUNTED EYE & FACE WASH NOZZLE WITH BOWL & FOOT TREADLE



SE475
PRATT WALL MOUNTED EYE & FACE WASH NOZZLE NO BOWL. NO FOOT TREADLE



SE505
PRATT WALL MOUNTED SINGLE NOZZLE EYE WASH WITH BOWL. NO FOOT TREADLE



SE575
PRATT WALL MOUNTED SINGLE NOZZLE EYE WASH NO BOWL. NO FOOT TREADLE



SE582FTL
PRATT WALL MOUNTED EYE WASH SINGLE NOZZLE WITH BOWL NO TREADLE - FLIP TOP LID

LABORATORY & SUPPLEMENTAL UNITS

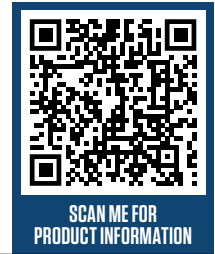

EVEN WHEN WORKING WITH SMALL DOSES OF DANGEROUS SUBSTANCES, SUCH AS IN A LABORATORY, A SPILL OR SPLASH COULD STILL CAUSE A SERIOUS INJURY.

Pratt's laboratory eyewashes provide laboratory practitioners swift and effective first aid treatment for chemical injuries and burns.

PS920

PRATT HAND HELD DRENCH HOSE SINGLE NON AERATED EYE WASH 1.5M HOSE



PS927

PRATT HAND HELD TWIN NON AERATED EYE WASH



536062

BENCH TOP MOUNT BRACKET

536061

WALL BRACKET FOR PS920 & PS927

EMERGENCY SHOWERS ACCESSORY OPTIONS

WITH PRATT BEING THE PIONEERS OF EMERGENCY SAFETY SHOWERS IN THE AUSTRALIAN MARKET, OUR EXPERTISE AND KNOWLEDGE IS PEACE OF MIND WE'RE ABLE TO OFFER THE RIGHT ADVICE ON THE APPROPRIATE SOLUTION FOR ANY SITUATION.

1. SIGNS

All emergency shower and eyewash units equipment identification and compliance to AS4775 and AS1319.

2. ALARM KITS

Alarm kits provide an effective means of warning other employees that the shower and/or eyewash station is in use and to render urgent assistance.

3. EMERGENCY LIGHTING

AS4775 requires the location of emergency eyewash and shower equipment to be well illuminated.

Green fluorescent lighting assists to identify the location of emergency equipment. Installation options on the shower or wall.

4. THERMAL PROTECTION

Thermal insulation of the safety shower from the effects of solar heating, help minimise the water temperature of stored water within the shower.

5. ANTI SCALD/ANTI FREEZE VALVES

Anti scald or Anti-freeze valves will automatically open when the flushing fluid reaches the pre-set opening temperature. When the fluid temperature changes to the pre-set closing temperature, the valve then closes.

6. CORROSIVE ENVIRONMENTS

Products are manufactured in 304 stainless steel as standard, with 316 stainless steel available as an option. To provide extra protection powder coating is available where emergency systems are installed in areas where chemicals are used or stored and in areas of high salinity. Custom colour options available.

YELLOW

GREEN

7. BOWL OPTIONS

When indoor bowls are a great option, when not indoors, consider no bowl options. For extra protection from dust and debris consider our flip top lid option.

3.

1.



2.



4.

6.

7.

5.

SHOWER ACCESSORIES



SETESTKIT
PRATT SHOWER TEST KIT WITH BIN



SE950
PRATT SHOWER TEST SOCK & RECEPTACLE



SETESTTAG
PRATT SHOWER AND EYE WASH TEST TAG - PACK OF 10



SEASV
PRATT ANTI SCALD VALVE ONLY 95°F/ 35°C RATED TEMPERATURE



SEASV-105
PRATT ANTI SCALD VALVE ONLY 105°F/40°C RATED TEMPERATURE



SEAFV
PRATT ANTI FREEZE VALVE ONLY



SEAERATORKEY
AERATOR REMOVAL KEY STAINLESS STEEL



SEEWGAUGE
EYEWASH TEST GAUGE PLASTIC TRANSPARENT



SE600TCF2

PRATT THERMAL INSULATING FOIL FOR SHOWER STANCHION



PSAL1

PRATT SHOWER AUDIBLE AND VISUAL ALARM KIT



PSGL1LED

GREEN LED LIGHT KIT

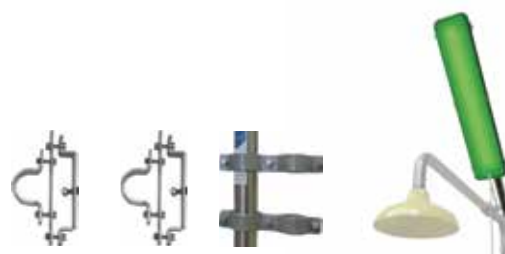

PSGL2LED

GREEN LED LIGHT & POLE MOUNTING KIT



SEILFS

PRATT FLOW SWITCH INLINE 25MM IP67

SHOWER ACCESSORIES

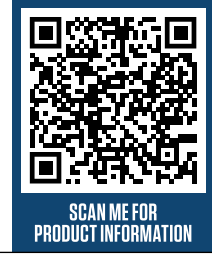

EEMEW



EEMSH



EESAE

P/NO	MATERIAL	SIZE	DESCRIPTION
EEMEW3022M	METAL	300x225mm	EMERGENCY EYEWASH
EEMEW3022P	POLY	300x225mm	EMERGENCY EYEWASH
EEMEW4530M	METAL	450x300mm	EMERGENCY EYEWASH
EEMEW4530P	POLY	450x300mm	EMERGENCY EYEWASH
EEMEW6045M	METAL	600x450mm	EMERGENCY EYEWASH
EEMEW6045P	POLY	600x450mm	EMERGENCY EYEWASH
EEMSH3022M	METAL	300x225mm	EMERGENCY SHOWER
EEMSH3022P	POLY	300x225mm	EMERGENCY SHOWER
EEMSH4530M	METAL	450x300mm	EMERGENCY SHOWER
EEMSH4530P	POLY	450x300mm	EMERGENCY SHOWER
EEMSH6045M	METAL	600x450mm	EMERGENCY SHOWER
EEMSH6045P	POLY	600x450mm	EMERGENCY SHOWER
EESAE3022M	METAL	300x225mm	EMERGENCY SHOWER & EYEWASH
EESAE3022P	POLY	300x225mm	EMERGENCY SHOWER & EYEWASH
EESAE4530M	METAL	450x300mm	EMERGENCY SHOWER & EYEWASH
EESAE4530P	POLY	450x300mm	EMERGENCY SHOWER & EYEWASH
EESAE6045M	METAL	600x450mm	EMERGENCY SHOWER & EYEWASH
EESAE6045P	POLY	600x450mm	EMERGENCY SHOWER & EYEWASH



PSSMB1

PRATT STANCHION SIGN MOUNTING BRACKET SMALL



PSSMB2

PRATT STANCHION SIGN MOUNTING BRACKET LARGE

A photograph of an emergency shower system mounted on a wall. The system includes a long, white, rectangular shower head at the top, connected by a metal pipe to a vertical riser pipe. A horizontal pipe extends from the riser pipe to a shower nozzle. A metal triangle with the word "PULL" on it is attached to the riser pipe. The background is a plain, light-colored wall. The image is overlaid with a dark blue gradient and a red triangle in the top-left corner.

LARGE RANGE OF EMERGENCY SHOWER
ACCESSORIES
AVAILABLE

SPARE PARTS

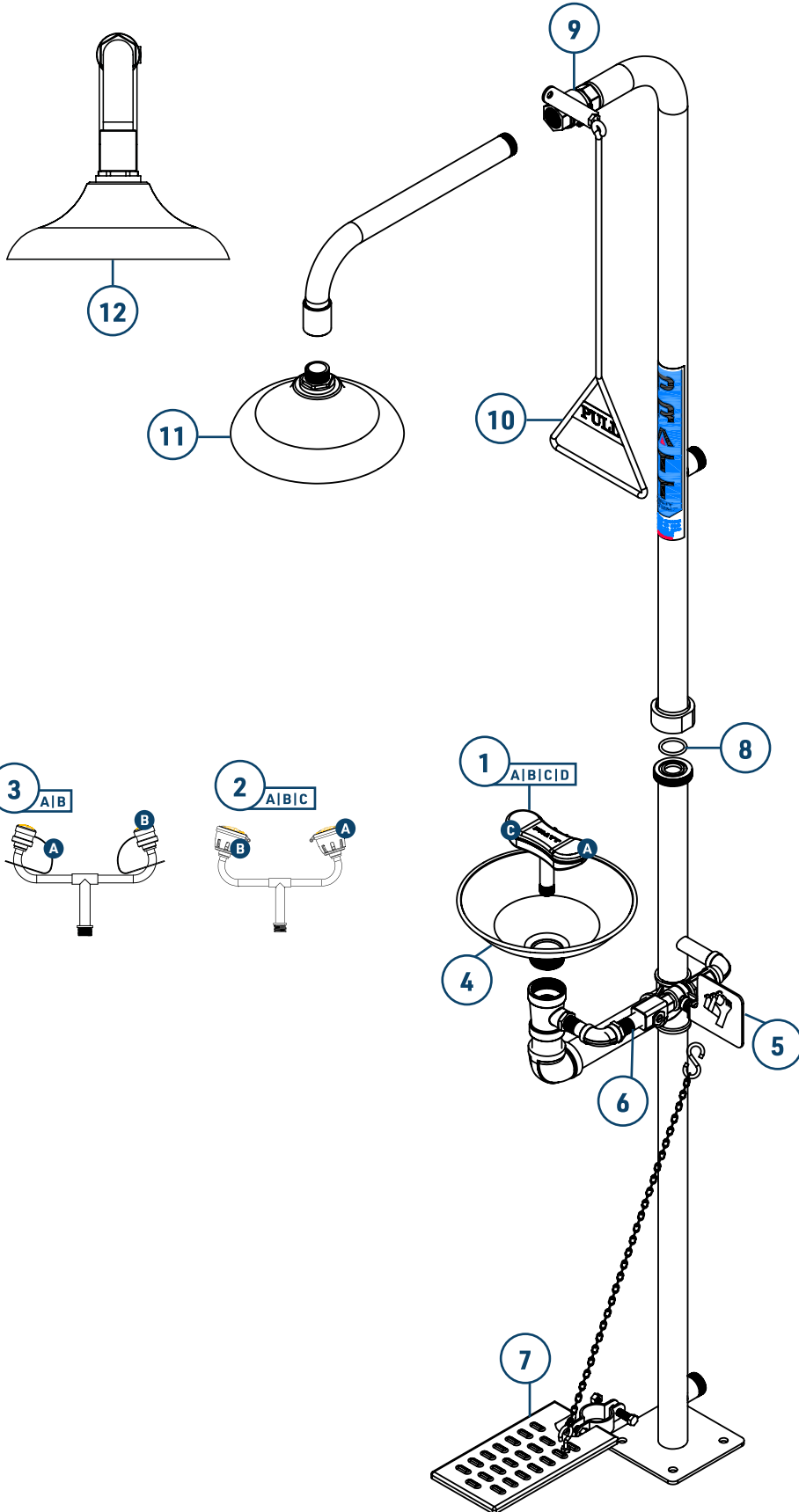

1



570027
PRATT EYE & FACE WASH NOZZLE YELLOW ABS PLASTIC SUITS ALL ELITE EYEWASH

1A



570029
PRATT DUST CAP ABS PLASTIC TO SUIT EYE & FACE WASH NOZZLE

1B



570030
PRATT SS304 SCREWS PACK OF 6 TO SUIT EYE & FACE WASH NOZZLE

1C



570031
PRATT AERATOR SUITS ALL EYE & FACE WASH INC. WASHER

1D



570032
PRATT 304 STAINLESS
STEEL RING SUITS EYE &
FACE WASH AERATOR

2



570003
PRATT EYEWASH NOZZLE
ASSEMBLY S/STEEL WITH
RUBBER EYECUP SUITS
ALL ELITE EYEWASH

2A 3B



570018
PRATT AERATOR SUITS
ALL ELITE AND ECONOMY
EYEWASH

2B



570017
PRATT RUBBER EYEWASH
CUP WITH YELLOW DUST
CAP SUITS ALL ELITE
EYEWASH

2C



570028
PRATT 304 STAINLESS
STEEL RING SUITS
EYEWASH AERATOR

3



570004
PRATT EYEWASH NOZZLE
ASSEMBLY S/STEEL WITH
YELLOW DUST CAP SUITS
SE693 AND FTL EYEWASH

3A



570023
PRATT YELLOW DUST
CAPS PLASTIC SUITS
SE693 AND FTL EYEWASH

4



570006
PRATT S/STEEL EYEWASH
BOWL SUITS ALL ELITE
EYEWASH

5



570010
PRATT S/STEEL PUSH
HANDLE FOR 570012 S/
STEEL BALL VALVE SUITS
ALL ELITE EYEWASH

6



570012
PRATT 15MM S/STEEL
BALL VALVE FOR 570010
S/STEEL PUSH HANDLE
SUITS ALL ELITE
EYEWASH

7



570020
PRATT S/STEEL FOOT
TREADLE SILVER SUITS
ALL ELITE EYEWASH

8



570024
PRATT BLACK WASHER
FOR STANCHION
JOINT SUITS ALL ELITE
SHOWERS

9



570014
PRATT 25MM S/STEEL
BALL VALVE WITH LEVER
ARM SUITS ALL ELITE
SHOWERS

10



570016
PRATT S/STEEL PULL ROD
SILVER SUITS ALL ELITE
SHOWERS

11



570007
PRATT ABS PLASTIC
SHOWER HEAD WITH
SWIRLTEC NOZZLE

12



570008
PRATT S/STEEL SHOWER
HEAD WITH SWIRLTEC
NOZZLE SUITS SE693

SPARE PARTS

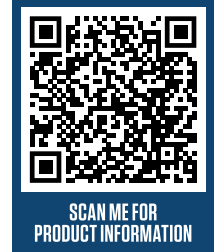

1
570027
PRATT EYE & FACE WASH NOZZLE YELLOW ABS PLASTIC SUITS ALL ELITE EYEWASH



2
570003
PRATT EYEWASH NOZZLE ASSEMBLY S/STEEL WITH RUBBER EYECUP SUITS ALL ELITE EYEWASH



1A
570029
PRATT DUST CAP ABS PLASTIC TO SUIT EYE & FACE WASH NOZZLE



2A 3B
570018
PRATT AERATOR SUITS ALL ELITE AND ECONOMY EYEWASH



1B
570030
PRATT SS304 SCREWS PACK OF 6 TO SUIT EYE & FACE WASH NOZZLE



2B
570017
PRATT RUBBER EYEWASH CUP WITH YELLOW DUST CAP SUITS ALL ELITE EYEWASH



1C
570031
PRATT AERATOR SUITS ALL EYE & FACE WASH INC. WASHER



2C
570028
PRATT 304 STAINLESS STEEL RING SUITS EYEWASH AERATOR



1D
570032
PRATT 304 STAINLESS STEEL RING SUITS EYE & FACE WASH AERATOR



3
570004
PRATT EYEWASH NOZZLE ASSEMBLY S/STEEL WITH YELLOW DUST CAP SUITS SE693 AND FTL EYEWASH



3A
570023
PRATT YELLOW DUST CAPS PLASTIC SUITS SE693 AND FTL EYEWASH

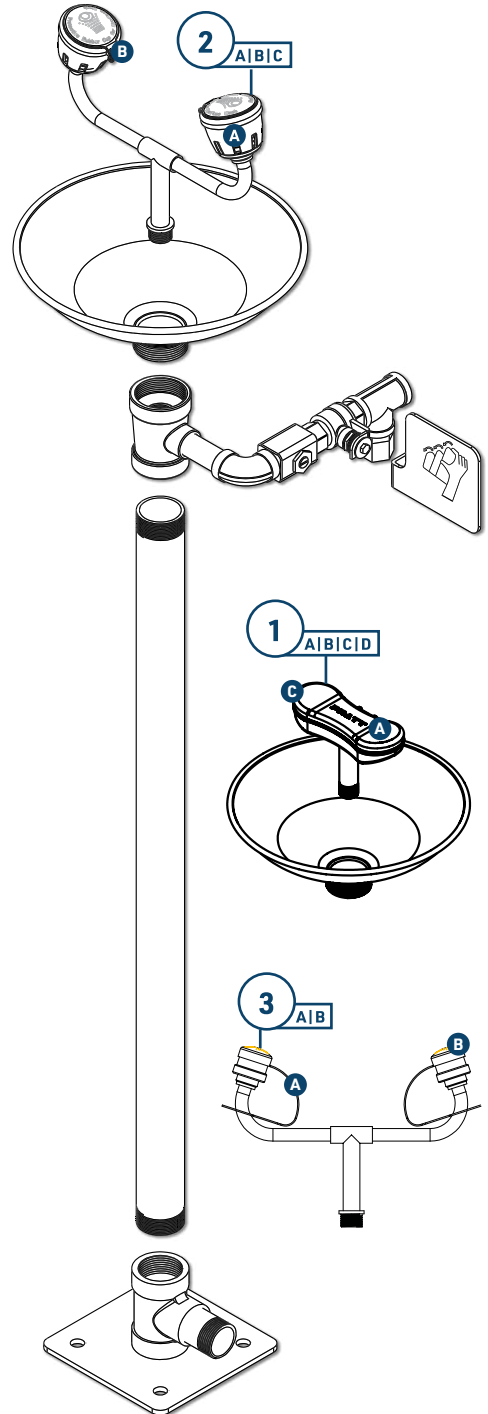

SPARE PARTS PRE 2021 SHOWER/EYEWASH MODELS

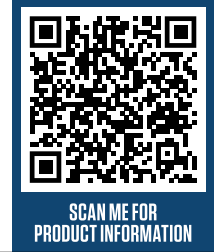

SE910
PRATT PUSH HANDLE &
15MM BALL VALVE KIT -
VERTICAL ASSEMBLY



SE911
PRATT 316 STAINLESS
STEEL 25MM BALL VALVE
AND LEVER ARM



531018
PRATT 316 STAINLESS
STEEL 15MM BALL VALVE



531020
PRATT PUSH HANDLE
HORIZONTAL ASSEMBLY



531027
PRATT FOOT TREADLE
ASSEMBLY



531038
PRATT PULL ROD FOR
SHOWERS



531113
PRATT DUST COVER CAP
FOR TRIPLE EYE & FACE
WASH NOZZLE ASSEMBLY



531120
PRATT DUST COVER CAPS
FOR SINGLE EYE WASH
NOZZLE ASSEMBLY
PK OF 2



531130
PRATT SINGLE AERATED
EYEWASH NOZZLE
ASSEMBLY



531131
PRATT TRIPLE AERATED
EYE AND FACE WASH
NOZZLE ASSEMBLY



05-1177
PRATT AERATOR SCREEN
ASSEMBLY SINGLE &
TRIPLE HEAD NOZZLES

SPARE PARTS PRE 2021 SHOWER/EYEWASH MODELS



511328

PRATT NEW 316 STAINLESS STEEL T JUNCTION AND NIPPLE MANIFOLD



520129WH

PRATT RIGHT HAND SS BRAIDED HOSE & ELBOW ASSEMBLY FOR SHOWERS



520130WH

PRATT LEFT HAND SS BRAIDED HOSE & ELBOW ASSEMBLY FOR SHOWERS



531121

PRATT DRAIN BOWL CONNECTOR KIT



531040

PRATT STAINLESS STEEL BRAIDED HOSE ASSEMBLY FOR NO BOWL SHOWERS



531044

PRATT STAINLESS STEEL SHOWER ARM



531108

PRATT STAINLESS STEEL BOWL ASSEMBLY



531132

PRATT HEX CAP 15MM FOR AUXILIARY OUTLET ON SHOWER STANCHIONS

SPARE PARTS PRE 2021 SHOWER/EYEWASH MODELS



PFCA90

**PRATT SHOWER ASSEMBLY FLOW CONTROL
REGULATOR FLOW RATE 90LPM**



511704

**PRATT STAINLESS STEEL SCREWS FOR
TRIPLE AERATED EYE & FACE WASH PK OF 10**



511706

PRATT TRIPLE EYE AND FACE WASH NOZZLE HOUSING



511756

**PRATT STAINLESS STEEL METERING
SCREW PACK OF 1 - FLAT**



511757

**PRATT STAINLESS STEEL METERING
SCREW PACK OF 1 - TAPERED**



SE850

316SS SHOWER HEAD WITH IMPELLER



SE870

PLASTIC SHOWER HEAD WITH IMPELLER. YELLOW

531051

**PUSH HANDLE & LINKAGE ASSEMBLY SUITS
NO-BOWL EYEWASH UNIT**

531007

PRATT CAP DUST EYE WASH SAFETY STATION (PAIR)

GRAVITY FED AND PRESSURISED

PORTABLE EYEWASH UNITS

WITH PRATT'S PORTABLE UNITS, YOU CAN HAVE A SAFE WORKPLACE NO MATTER WHERE YOU ARE.

Portable units provide immediate, supplementary support and are ideal for worksites.

The twin eyewash complies to AS4775 but in Australia the SE593A shower and the units with the PS920 Drench Hose are considered supplementary support, and may not replace the need for a primary eye wash station as outlined in AS4775-2007.

GRAVITY FED UNITS & ACCESSORIES

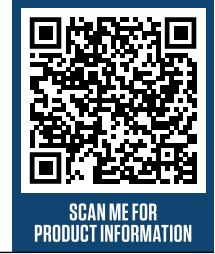

SE5050
PRATT PORTABLE GRAVITY FED EYE WASH UNIT. 55 LTR



SE5000
PRATT PORTABLE GRAVITY FED EYE WASH UNIT. 35 LTR



SE4764
PRATT WATER PRESERVATIVE SOLUTION
4 PACK 250ML BOTTLES



SE5000TC
PRATT THERMAL COVER FOR SE5000



SE5050TC
PRATT THERMAL COVER FOR SE5050

PORTABLE PRESSURISED UNITS

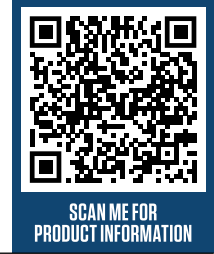

SE590A

PRATT PORTABLE PRESSURISED EYE AND BODY WASH WITH HAND HELD DRENCH HOSE. 45LTR UNIT



SE593A

PRATT PORTABLE PRESSURISED COMBO SHOWER & TWIN EYE WASH 106LTR UNIT



ACCESSORIES FOR PRESSURISED UNITS



SCAN ME FOR
PRODUCT INFORMATION



PS590TC

PRATT THERMAL COVER. SUITS SE590A, SE591A, SE592A



PS593TC

PRATT THERMAL COVER FOR SE593A



PS590TR

PORTABLE EYEWASH TROLLEY TO SUIT SE590A



SE593A-TR

HEAVY DUTY TROLLEY WITH STRAP FOR SE593A

DANGEROUS GOODS STORAGE CABINETS

**PRATT SAFETY SYSTEMS HAS BEEN MANUFACTURING
AND DISTRIBUTING CABINETS FOR OVER 30 YEARS**

**ALL PRATT CABINETS ARE DESIGNED AND
MANUFACTURED IN ISO9001 ACCREDITED FACILITY
WITH FULL CONFORMANCE TO AUS/NZ STANDARDS.**

When choosing your Pratt storage cabinet, it is crucial that the types of dangerous goods and the hazards they present are correctly understood, so as to choose the right cabinet and to segregate incompatible substances.





SAFETY INSTRUCTIONS
READ AND UNDERSTAND THESE INSTRUCTIONS BEFORE USING THIS PRODUCT.
...
PRATT
CUSTOMER SERVICE
1-800-433-2264



DANGEROUS GOODS INDOOR STORAGE CABINETS

PRATT SAFETY SYSTEMS HAS BEEN MANUFACTURING AND DISTRIBUTING CABINETS FOR OVER 30 YEARS. ALL PRATT CABINETS ARE DESIGNED AND MANUFACTURED IN ISO9001 ACCREDITED FACILITY WITH FULL CONFORMANCE TO AUS/NZ STANDARDS.

CLASS 3 FLAMMABLE LIQUIDS ARE LIQUIDS, or mixtures of liquids, or liquids containing solids in solution or suspension (but not including substances otherwise classified on account of their dangerous characteristics) which give off a flammable vapour at temperatures of not more than 60°C, closed-cup test, or not more than 65.6°C, open-cup test, normally referred to as the flash point.

CLASS 4 FLAMMABLE SOLIDS ARE MADE UP OF THE FOLLOWING SUB-DIVISIONS:

DIVISION 4.1 FLAMMABLE SOLIDS

- **FLAMMABLE SOLIDS**, readily combustible and may cause or contribute to fire through friction. They can also be a powder or paste.
- **SELF-REACTIVE SUBSTANCE**, thermally unstable substances that are liable to undergo a strong exothermic reaction (heat release), or decomposition even without participation of air.
- **SOLID DESENSITIZED EXPLOSIVES**, substances that are wetted with water, alcohol or are diluted with other substances to form a solid mixture to suppress their explosive properties. Desensitized explosives may explode if not diluted sufficiently.
- **POLYMERIZING SUBSTANCES** are substances which, without stabilisation, are liable to undergo a strongly exothermic reaction resulting in the formation of larger molecules or resulting in the formation of polymers.

DIVISION 4.2 SUBSTANCES LIABLE TO SPONTANEOUS COMBUSTION

- **PYROPHORIC SUBSTANCES** are substances, including mixtures and solutions (liquid or solids) which can ignite upon contact with oxygen, even in small quantities. These Division 4.2 substances are the most liable to spontaneous combustion.
- **SELF-HEATING SUBSTANCES** are substances, other than pyrophoric substances, which in contact with air, and without energy supply, are liable to self-heating. These substances will ignite only when in large amounts and after long periods of time.

DIVISION 4.3 SUBSTANCES WHICH IN CONTACT WITH WATER EMIT FLAMMABLE GASES

- **DANGEROUS WHEN WET** substances which when in contact with water may emit flammable gases that can form explosive mixtures with air. Such mixtures are easily ignited by all ordinary ignition sources, e.g. naked lights, sparking hand tools, or unprotected light bulbs. The resulting blast wave and flames may endanger people and the environment. Emitting gases may also be toxic.

CLASS 5.1 OXIDIZING AGENTS are substances which, although not necessarily combustible, may, readily liberate oxygen, or be the cause of oxidizing processes and, as a result, may start a fire in, or stimulate the combustion of other materials. Oxidizing agents can be either solids or liquids.

CLASS 5.2 ORGANIC PEROXIDES are thermally unstable substances, which may undergo exothermic self-accelerating decomposition. They are sensitive to heat and therefore prone to decomposition by burning. Under certain circumstances, such as high temperatures, and inadequate segregation from incompatible substances, organic peroxides can ignite and cause uncontrollable fires. Some organic peroxides are corrosive, which means that they can attack and destroy metals. In addition, they may have one or more of the following properties:

- be liable to explosive decomposition
- burn rapidly
- be sensitive to impact or friction
- react dangerously with other substances
- cause damage to the eyes

CLASS 6.1 TOXIC SUBSTANCES are those which can cause death, serious injury or harm to human health through skin absorption, inhalation, or ingestion.

CLASS 8 CORROSIVE substances are substances which, by chemical action, will cause severe damage when in contact with living tissue, or, in the case of leakage, will materially damage, or even destroy, other goods, or the means of transport and may also cause other hazards.

Corrosive substances are also divided into two main types; Acids and Alkalis, which are defined by their pH balance. Acids are less than 7.0 pH, whereas Alkalis are more than 7.0 ph. However, Acids and Alkalis should also be stored separately, as they can react violently if mixed.



**PRATT SAFETY SYSTEMS HAS BEEN
MANUFACTURING AND DISTRIBUTING CABINETS
FOR OVER 30 YEARS**

CLASSIFICATIONS LABELS:

All appropriate classification, capacity labels, identification and instruction labels are applied to each indoor cabinet.

MANUFACTURED IN ISO9001 ACCREDITED FACILITY

All cabinets are designed and manufactured to full conformance of AUS/NZ Standards.



POWDER COATED PAINT FINISH:

Our metal indoor cabinets have an epoxy resin powder coating internally & externally, for improved chemical resistance.

50MM VENT BUNGS:

Fitted into side walls of indoor metal cabinets, to allow for venting where required. Each vent incorporates a steel flash arrester. Each vent is supplied with resealable metal caps.



SELF-CLOSING DOORS:

All metal two door cabinets incorporate Pratt's unique and improved sequential self-closing door action, providing hands free closing and ensures doors close in the correct sequence. All metal indoor single door cabinets have self-closing door mechanism.

WALLS:

Indoor metal cabinets are constructed using 1.2mm thick, double steel walls with 40mm air gap between walls to provide thermal insulation.

150MM DEEP LIQUID TIGHT SUMP:

For containment of leakage or spillage.



SHELVES:

All metal indoor cabinets come with 1.6mm thick perforated galvanised steel shelves provide added strength and free air movement within the cabinet

FULLY ADJUSTABLE SHELVES:

Indoor metal cabinets have 90mm shelving increments for large cabinets and 45mm for medium and small cabinets.



FLAMMABLE LIQUID STORAGE CABINET

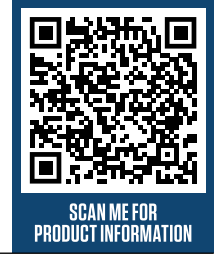

PRATT INDOOR FLAMMABLE LIQUID STORAGE CABINETS COMPLY WITH THE AUSTRALIAN STANDARD AS1940 "THE STORAGE AND HANDLING OF FLAMMABLE AND COMBUSTIBLE LIQUIDS".

This range of cabinets is suitable for the storage of flammable or combustible liquids as classified by the United Nations criteria and the ADG Code for Dangerous Goods. These include flammable liquids such as Paints, Solvents, Petrol, Thinners, Kerosene, Turpentine, White Spirits, Alcohol and Ethanol. Also, combustible liquids such as Diesel, Linseed Oil and Pine Oil.



Part number: DGFLB2727A
 Description: PRATT DANGEROUS GOODS FLAMMABLE LIQUID 3 270 X 270 S/A LABEL

Part number: 717053
 Description: PRATT DANGER NO SMOKING NO IGNITION SOURCES 360 X 270 LABEL also



MODEL	CAPACITY	DOORS	SHELVES		EXTRA SHELF	WEIGHT	EXTERNAL (mm)			INTERNAL (mm)		
			INC. BASE LEVEL				HEIGHT	WIDTH	DEPTH H	HEIGHT	WIDTH	DEPTH H
5516AS	30L	1	1		5517-29S	53kg	770	515	465	525	420	370
5517AS	60L	1	2		5517-29S	62kg	1065	515	465	820	420	370
5535AS	100L	2	1		5535-29S	100kg	770	935	620	495	840	530
5530AS	160L	2	2		5545-29S	141kg	1295	1115	500	1015	1020	415
5545AS	250L	2	3		5545-29S	185kg	1825	1115	500	1545	1020	415
5560AS	350L	2	3		5560-29S	230kg	1825	1440	585	1545	1350	495
5560ASE	350L	1	3		5560E-29S	180kg	1825	865	865	1580	770	775
5555VS	205L	1	ROLLER SET		-	180kg	1825	865	865	1580	770	775
5590AS	425L	2	3		5590-29S	247kg	1825	1115	865	1545	1015	775

Note: 1. For all two door cabinets, the internal height is taken from top of sump sill/bottom shelf to the sequential chassis assembly. 2. For all single door cabinets, the internal height is taken from the top of the sump sill/bottom shelf to the ceiling. 3. For total external width measurement, add 6mm per vent bung for tight clearance locations.

CORROSIVE SUBSTANCE STORAGE CABINETS - METAL



PRATT INDOOR CORROSIVE SUBSTANCE STORAGE CABINETS COMPLY WITH AS3780 "THE STORAGE AND HANDLING OF CORROSIVE SUBSTANCES".

This range of cabinets is for the storage of Corrosive Substances in liquid or solid as classified by the United Nations criteria and the ADG Code for Dangerous Goods. These include chemicals such as: Acids, Alkalis, Caustics, Sodium Hydroxide Solution, Hypochlorite Solution etc.



Part number: DGCOR2727A
Description: PRATT DANGEROUS GOODS CORROSIVE 8 270 X 270 S/A LABEL



5516ASPH

5517ASPH

5535ASPH

5530ASPH

5545ASPH

5560ASPH

5590ASPH

MODEL	CAPACITY	DOORS	SHELVES	EXTRA SHELF	EXTRA TRAY	WEIGHT	EXTERNAL (mm)			INTERNAL (mm)		
							HEIGHT	WIDTH	DEPTH H	HEIGHT	WIDTH	DEPTH H
5516ASPH	30kg or L*	1	1	5517PH-29S	5517-29TS x 1	53kg	770	515	465	525	420	370
5517ASPH	60kg or L*	1	2	5517PH-29S	5517-29TS x 2	62kg	1065	515	465	820	420	370
5535ASPH	100kg or L*	2	1	5535PH-29S	5535-29TS x 1	100kg	770	935	620	495	840	530
5530ASPH	160kg or L*	2	2	5545PH-29S	5545-29TS x 2	141kg	1295	1115	500	1015	1020	415
5545ASPH	250kg or L*	2	3	5545PH-29S	5545-29TS x 3	185kg	1825	1115	500	1545	1020	415
5560ASPH	350kg or L*	2	3	5560PH-29S	5545-29TS x 3 5517-29TS x 3	230kg	1825	1440	585	1545	1350	495
5590ASPH	425kg or L*	2	3	5590PH-29S	5545-29TS x 6	247kg	1825	1115	865	1545	1015	775

* AS3780 specifies a maximum of 50kg or L for Packaging Group I Corrosive Substances and 250kg or L for Packaging Group II.

Note: 1. These cabinets are designed for the safe storage of corrosives in sealed and closed containers. Good housekeeping practices are essential to ensure long service life. 2. For all two door cabinets, the internal height is taken from top of sump sill/bottom shelf to the sequential chassis assembly. 3. For all single door cabinets, the internal height is taken from the top of the sump sill/bottom shelf to the ceiling. 4. For total external width measurement, add 6mm per vent bung for tight clearance locations.

CORROSIVE SUBSTANCE STORAGE CABINETS - POLYETHYLENE

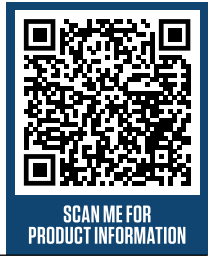

PRATT POLY CORROSIVE SUBSTANCE STORAGE CABINETS HAVE BEEN UPDATED WITH NEW MATERIALS, IMPROVED DESIGN AND CONSTRUCTION.

The cabinets are now made from white polypropylene material which match the décor and meet the high finish standards of many laboratories. The cabinet material provides a superior resistance for the storage of most aggressive corrosive chemicals, such as Sulphuric Acid, Hydrochloric Acid, Nitric Acid and other substances highly aggressive to metal. The cabinets are designed and manufactured to comply with the requirements of AS3780 "The Storage and Handling of Corrosive Substances".



Part number: DGCOR2727A
 Description: PRATT DANGEROUS GOODS CORROSIVE 8 270 X 270 S/A LABEL



MODEL	CAPACITY	DOORS	SHELVES	EXTRA SHELF	WEIGHT	EXTERNAL (mm)			INTERNAL (mm)		
			INC. BASE LEVEL			HEIGHT	WIDTH	DEPTH H	HEIGHT	WIDTH	DEPTH H
5512PSPH	20kg or L*	1	1	5512P-29	26kg	600	460	466	420	430	426
5516PSPH	40kg or L*	1	1	5516P-29	35kg	770	600	466	590	570	426
5517PSPH	80kg or L*	1	2	5516P-29	46kg	1150	600	466	970	570	426
5535PSPH	100kg or L*	2	1	5535P-29	53kg	770	880	606	590	850	566
5540PSPH	110kg or L*	2	2	5545P-29	65kg	770	1000	600	590	970	560
5530PSPH	160kg or L*	2	4	5545P-29	92kg	1150	1000	600	970	970	560
5545PSPH	250kg or L*	2	6	5545P-29	120kg	1550	1000	600	1370	970	560

* AS3780 specifies a maximum of 50kg or L for Packaging Group I Corrosive Substances and 250kg or L for Packaging Group II.

Note: 1. These cabinets are designed for the safe storage of corrosives in sealed and closed containers. Good housekeeping practices are essential to ensure long service life. 2. Check chemical compatibility of stored chemicals with polypropylene material to ensure suitability. 3. For all two door cabinets, the internal height is taken from top of sump sill/bottom shelf to the sequential chassis assembly. 4. For all single door cabinets, the internal height is taken from the top of the sump sill/bottom shelf to the ceiling.

TOXIC SUBSTANCE STORAGE CABINETS

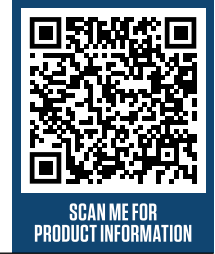

PRATT INDOOR TOXIC SUBSTANCE STORAGE CABINETS COMPLY WITH THE AUSTRALIAN & NEW ZEALAND STANDARD AS/ NZS4452 "THE STORAGE AND HANDLING OF TOXIC SUBSTANCES".

This range of cabinets is for the storage of Toxic Substances in liquid or solid as classified by the United Nations criteria and the ADG Code for Dangerous Goods. These include chemicals such as: Alkaloids, Arsenic, Aniline, Cyanides, Mercury, Phenol - Solid, Trichloroethylene, etc.



Part number: DGTOX2727A
 Description: PRATT DANGEROUS GOODS TOXIC 6 270 X 270 S/A LABEL



MODEL	CAPACITY	DOORS	SHELVES	EXTRA SHELF	WEIGHT	EXTERNAL (mm)			INTERNAL (mm)		
						HEIGHT	WIDTH	DEPTH H	HEIGHT	WIDTH	DEPTH H
5516AST	30kg or L	1	1	5517-29S	53kg	770	515	465	525	420	370
5517AST	60kg or L*	1	2	5517-29S	62kg	1065	515	465	820	420	370
5535AST	100kg or L*	2	1	5535-29S	100kg	770	935	620	495	840	530
5530AST	160kg or L*	2	2	5545-29S	141kg	1295	1115	500	1015	1020	415
5545AST	250kg or L*	2	3	5545-29S	185kg	1825	1115	500	1545	1020	415
5560AST	250kg or L*	2	3	5560-29S	230kg	1825	1440	585	1545	1350	495

* AS/NZS 4452 specifies a maximum of 25kg or L for Packaging Group I and 50kg or L for Packaging Group II Toxic Substances.
 Note: 1. For all two door cabinets, the internal height is taken from top of sump sill/bottom shelf to the sequential chassis assembly. 2. For all single door cabinets, the internal height is taken from the top of the sump sill/bottom shelf to the ceiling. 3. For total external width measurement, add 6mm per vent bung for tight clearance locations.

OXIDIZING AGENT STORAGE CABINETS

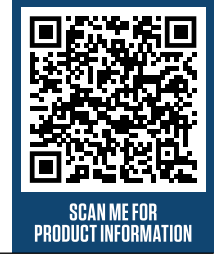

PRATT INDOOR OXIDIZING AGENT STORAGE CABINETS COMPLY WITH THE AUSTRALIAN STANDARD AS4326 "THE STORAGE AND HANDLING OF OXIDIZING AGENTS".

This range of cabinets is for the storage of Oxidizing Agents in liquid or solid as classified by the United Nations criteria and the ADG Code for Dangerous Goods. These include chemicals such as: Hypochlorite-inorganic, Hydrogen Peroxide, Perchlorites-inorganic, Potassium Nitrate etc.



Part number: DGOXA2727A
 Description: PRATT DANGEROUS GOODS OXIDISING AGENT 5.1 270 X 270 S/A LABEL



5516AOA

5517AOA

5535AOA

5530AOA

5545AOA

MODEL	CAPACITY	DOORS	SHELVES	EXTRA SHELF	WEIGHT	EXTERNAL (mm)			INTERNAL (mm)		
						HEIGHT	WIDTH	DEPTH H	HEIGHT	WIDTH	DEPTH H
5516AOA	30kg or L*	1	1	5517-29S	53kg	770	515	465	525	420	370
5517AOA	60kg or L*	1	2	5517-29S	62kg	1065	515	465	820	420	370
5535AOA	100kg or L*	2	1	5535-29S	100kg	770	935	620	495	840	530
5530AOA	160kg or L*	2	2	5545-29S	141kg	1295	1115	500	1015	1020	415
5545AOA	250kg or L*	2	3	5545-29S	185kg	1825	1115	500	1545	1020	415

* AS 4326 specifies a maximum of 50kg or L for Packaging Group I Oxidizing Agents.

Note: 1. For all two door cabinets, the internal height is taken from top of sump sill/bottom shelf to the sequential chassis assembly. 2. For all single door cabinets, the internal height is taken from the top of the sump sill/bottom shelf to the ceiling. 3. For total external width measurement, add 6mm per vent bung for tight clearance locations.

ORGANIC PEROXIDE STORAGE CABINETS



PRATT INDOOR ORGANIC PEROXIDE STORAGE CABINETS COMPLY WITH THE AUSTRALIAN STANDARD AS2714 "THE STORAGE AND HANDLING OF ORGANIC PEROXIDES".

This range of cabinets is for the storage of Organic Peroxides in liquid or solid as classified by the United Nations criteria and the ADG Code for Dangerous Goods. These include chemicals such as: Acetyl Acetone Peroxide, Methyl Ethyl Ketone Peroxides, Dibenzoyl Peroxide etc.



Part number: DGOPB2727A
 Description: PRATT DANGEROUS GOODS ORGANIC PEROXIDE 5.2 270 X 270 S/A LABEL



5516APO

5517APO

5535APO

5530APO

5545APO

MODEL	CAPACITY	DOORS	SHELVES	EXTRA SHELF	WEIGHT	EXTERNAL (mm)			INTERNAL (mm)		
						HEIGHT	WIDTH	DEPTH H	HEIGHT	WIDTH	DEPTH H
5516APO	30kg or L	1	1	5517-29S	53kg	770	515	465	525	420	370
5517APO	60kg or L*	1	2	5517-29S	62kg	1065	515	465	820	420	370
5535APO	100kg or L*	2	1	5535-29S	100kg	770	935	620	495	840	530
5530APO	100kg or L*	2	2	5545-29S	141kg	1295	1115	500	1015	1020	415
5545APO	100kg or L*	2	3	5545-29S	185kg	1825	1115	500	1545	1020	415

* AS 2714 specifies a maximum of 50kg or L for Type B Organic Peroxides.

Note: 1. For all two door cabinets, the internal height is taken from top of sump sill/bottom shelf to the sequential chassis assembly. 2. For all single door cabinets, the internal height is taken from the top of the sump sill/bottom shelf to the ceiling. 3. For total external width measurement, add 6mm per vent bung for tight clearance locations.

CLASS 4 DANGEROUS GOODS STORAGE CABINETS

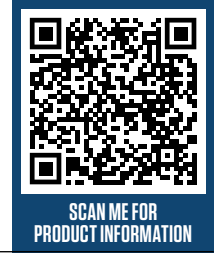

PRATT INDOOR CLASS 4 STORAGE CABINETS COMPLY WITH THE STANDARD AS/NZS5026 "THE STORAGE AND HANDLING OF CLASS 4 DANGEROUS GOODS".

This range of cabinets is for the storage of Class 4 chemicals in liquid or solid form as classified by the United Nations criteria and the ADG Code for Dangerous Goods. Please refer to the Standard. These include the following divisions: Flammable Solids, Spontaneously or Combustible Dangerous when wet.



Part number: DGSPC2727A
Description: PRATT DANGEROUS GOODS SPONTANEOUSLY COMBUSTIBLE 270 X 270 S/A LABEL



Part number: DGDWW2727A
Description: PRATT DANGEROUS GOODS DANGEROUS WHEN WET 270 X 270 S/A LABEL



Part number: DGFSB2727A
Description: PRATT FLAMMABLE SOLID CL4 DIAMOND 270 X 270 S/A LABEL

Part number: 717053
Description: PRATT DANGER NO SMOKING NO IGNITION SOURCES 360 X 270 LABEL



5516AC4



5517AC4



5535AC4



5530AC4



5545AC4

MODEL	CAPACITY	DOORS	SHELVES	EXTRA SHELF	WEIGHT	EXTERNAL (mm)			INTERNAL (mm)		
						HEIGHT	WIDTH	DEPTH H	HEIGHT	WIDTH	DEPTH H
5516AC4	30kg or L*	1	1	5517-29S	53kg	770	515	465	525	420	370
5517AC4	60kg or L*	1	2	5517-29S	62kg	1065	515	465	820	420	370
5535AC4	100kg or L*	2	1	5535-29S	100kg	770	935	620	495	840	530
5530AC4	160kg or L*	2	2	5545-29S	141kg	1295	1115	500	1015	1020	415
5545AC4	250kg or L*	2	3	5545-29S	185kg	1825	1115	500	1545	1020	415

* AS/NZS 5026 specifies a maximum of 25kg or L for Category A, 50kg or L of Category B or 100kg or L of Category C, Class 4 Chemicals. Other capacity limitations do apply. Refer to the Standard for further details.

Note: 1. For all two door cabinets, the internal height is taken from top of sump sill/bottom shelf to the sequential chassis assembly. 2. For all single door cabinets, the internal height is taken from the top of the sump sill/bottom shelf to the ceiling. 3. For total external width measurement, add 6mm per vent bung for tight clearance locations.

HAZMAT EMERGENCY INFORMATION CABINET

PHAZCAB

HAZMAT EMERGENCY INFORMATION CABINET 500 X 600 X 100

- A manifest is required where a premises is storing and handling dangerous goods in quantities that exceed the "Manifest Quantity" as shown in Schedule 2 of the Regulation. Refer to the Regulation for the relevant information required for the manifest document.
- This information should be kept in a suitable Manifest Cabinet located in the premises in a place where it is readily accessible to the emergency services authority.
- A Manifest cabinet should be installed at the entrance to the property and contain;
 1. Site Map showing the location of hazardous chemicals and the location of all fire fighting equipment.
 2. Copies of Material Safety Data Sheets for all chemicals stored on site
 3. A 24 hour phone number to be used in an emergency
 4. The cabinet should have locking systems compatible to the local Fire Brigade.
- Fitted with a 003 Combination Lock

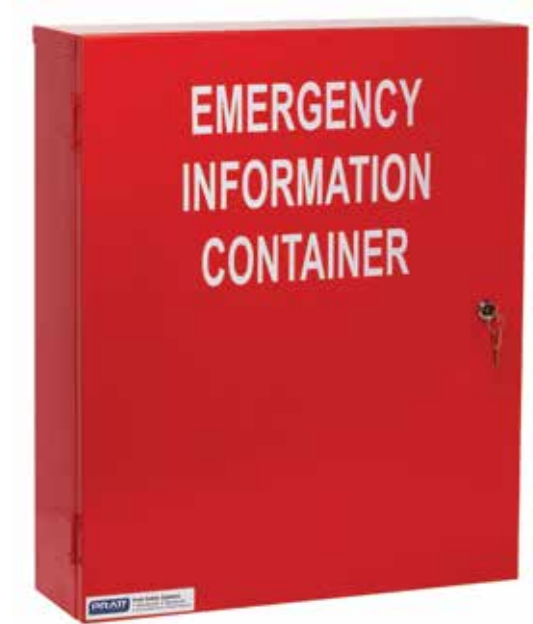

PHAZCABKEY

SPARE CABINET KEYS

- Spare Keys for PHAZCAB
- Type: Spare par



DANGEROUS GOODS OUTDOOR CABINETS



PRATT DANGEROUS GOODS OUTDOOR STORAGE CABINETS ARE MANUFACTURED TO COMPLY WITH THE REQUIREMENTS OF AUSTRALIAN STANDARD AS 1940, CLASS 3 AS1940, CLASS 5.1 AS4326, CLASS 5.2 AS2714 & CLASS 6 AS4452.

This range of cabinets provide a convenient and secure enclosure and helps with good house-keeping practices for the storage of dangerous goods. They are suitable for outdoor use only.

SPECIAL FEATURES:

- Only Suitable for Flammable, Oxidizing, Organic Per & Toxic Substances
- Constructed of heavy duty single walled galvanised steel.
- Door and rear panel incorporate weatherproof louvered constant ventilation.
- Manual closing door with ISO two-point latching bar.
- Provision for padlock for added security.
- Rubber door seal for added weather protection.
- Two heavy duty door hinges allowing 270° opening to aid loading and unloading.
- Fixed heavy duty open mesh bottom shelf.
- Heavy duty galvanised steel adjustable shelf.
- External static earthing connection point at base of cabinet including a metal earthing stake with connecting earthing wire.
- Durable weather and solvent resistant blue powder coated paint finish, both internal and external.
- 150mm deep liquid tight sump for spill collection.
- Front accessible removal sump plug for drainage.
- 4 x heavy duty lifting lugs.
- Heavy duty foot plates with provision for bolting to concrete footing.
- Forklift channels for ease of moving by forklift.
- Palletised and packaged in strong cardboard for protection during transportation and storage.
- Appropriate labelling applied.



MODEL	CAPACITY	DOORS	SHELVES INC. BASE LEVEL	WEIGHT	EXTERNAL (mm)			INTERNAL (mm)		
					HEIGHT	WIDTH	DEPTH H	HEIGHT	WIDTH	DEPTH H
POD80	80 L	1	2	70kg	1375	785	635	1165	780	455
POD160	160 L	1	2	90kg	1375	785	900	1165	770	720
POD250	250 L	1	2	130kg	1375	1035	900	1165	1025	720
POD250D	250 L	1	3	140kg	1857	785	900	1647	780	720
POD350	350 L	1	3	185kg	1870	1185	900	1660	1180	720
POD450	450 L	2	6	220kg	1870	1535	900	1660	1530	720

Notes: External height includes feet.

CONVENIENT & SECURE ENCLOSURE

THIS RANGE OF CABINETS
PROVIDE A CONVENIENT AND
SECURE ENCLOSURE AND HELPS
WITH GOOD HOUSE-KEEPING
PRACTICES FOR THE STORAGE
OF DANGEROUS GOODS.



Part number: DGFLB2727A
Description: PRATT DANGEROUS
GOODS FLAMMABLE LIQUID 3
270 X 270 S/A LABEL



Part number: DG0XA2727A
Description: PRATT DANGEROUS
GOODS OXIDISING AGENT 5.1
270 X 270 S/A LABEL



Part number: DGOPB2727A
Description: PRATT DANGEROUS
GOODS ORGANIC PEROXIDE 5.2
270 X 270 S/A LABEL



Part number: DGTOX2727A
Description: PRATT DANGEROUS
GOODS TOXIC 6 (PTM6.1TV)
270 X 270 S/A LABEL



GAS CYLINDER & AEROSOL CAN STORAGE CAGES

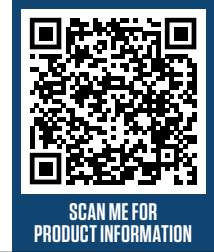

PRATT SAFETY SYSTEMS OFFER A COMPREHENSIVE RANGE OF GAS CYLINDER STORAGE CAGES TO SUIT MOST STORAGE REQUIREMENTS. WHETHER IT IS FOR STORING AEROSOL CANS, GAS CYLINDERS, FORKLIFT GAS CYLINDERS OR A MIXTURE. ALL PRATT GAS CYLINDER STORAGE CAGES COMPLY WITH THE REQUIREMENTS OF AUSTRALIAN STANDARD AS 4332 AND AS/NZS 1596. REFER TO THESE STANDARDS FOR MORE SPECIFIC STORAGE REQUIREMENTS AND COMPLIANCE.

CLASS 2: GASES

It is recommended the storage of Class 2 Gases should be within a wire mesh enclosure, such as our Pratt range of Gas Cylinder and Aerosol Storage Cages. These cages provide a secure storage facility for gas cylinders, encouraging good housekeeping, protection and isolation of the stored cylinders.

Many workplaces follow the guidelines of Australian Standard AS1940:2017 the storage and handling of flammable and combustible liquids and choose to store their aerosols in a flammable liquids cabinet. Aerosols of Divisions 2.1 and 2.2 may be stored in a store for Class 3 dangerous goods if projectile protection (e.g. cages) is provided.

We would recommend you separate these and store the Aerosols in a dedicated aerosol cages away from the Cabinet.

Division: 2.1 Flammable gases

Division: 2.2 Non-flammable, non-toxic gases

Division: 2.3 Gas Toxic gases

Not all gases can be stored together. The following gases should be stored in separate cages. For example:

Division 2.1: Flammable Gases should not be stored with Division 2.3 Toxic Gases.

Division 2.1: Flammable Gases should not be stored with Division 2.2/5.1 Oxidizing Gases.

Division 2.2/5.1 Oxidizing Gases should not be stored with Division 2.3 Toxic Gases.

When selecting a gas cylinder storage cage, the above criteria must be considered, together with the type of gas, number, and sizing of the cylinders to be stored.

Further consideration must be given to the location of the storage cage as it is recommended they be located outdoors to allow for any leakage of gas to dissipate into the outside air.



ALL PRATT GAS CYLINDER STORAGE CAGES COMPLY WITH THE REQUIREMENTS OF AUSTRALIAN STANDARD AS4332 AND AS/NZS1596. REFER TO THESE STANDARDS FOR MORE SPECIFIC STORAGE REQUIREMENTS AND COMPLIANCE.

SPECIAL FEATURES:

- Yellow powder coated steel construction, suitable for outdoor environments.
- Solid steel roof and floor with steel mesh sides to provide ventilation
- All wall panels and doors are made of welded steel mesh within a sturdy steel frame for added strength.
- Strong magnetic door catches to hold doors closed and an eye lug for a padlock.
(Are not valid for the 1A & 2A aerosol cages)
- Raised support legs with pre-drilled feet which can be permanently fixed to the ground. (Recommended)
(Are not valid for the 1A & 2A aerosol cages)
- Capable of being moved by a forklift for relocation if required. Note - only when cage is empty of cylinders.
- Available in a range of configurations for tall gas cylinders and forklift gas cylinders.
- Tall forklift cylinder storage cages include shelf to provide storage on two levels.
- Restraining chain to prevent cylinders from falling.



PSGC1A-FP



PSGC2A-FP



PSGC4A PSGC4F



PSGC8A PSGC8F
PSGC9V PSGC16A



PSGC16F
PSGC18V PSGC8F9V

FLAT PACKED	ASSEMBLED	CAPACITY	STORAGE LEVELS	WEIGHT	HEIGHT (mm)	WIDTH (mm)	DEPTH (mm)	
	PSGC1A-FP	N/A	UP TO 42 AEROSOL CANS	1	kg	360	560	490
	PSGC2A-FP	N/A	UP TO 84 AEROSOL CANS	2	kg	660	560	490
	PSGC4A-FP	PSGC4A	UP TO 200 AEROSOL CANS	2	kg	990	780	760
	PSGC8A-FP	PSGC8A	UP TO 400 AEROSOL CANS	4	kg	1920	780	760
	PSGC16A-FP	PSGC16A	UP TO 800 AEROSOL CANS	4	kg	1920	1520	760
	PSGC4F-FP	PSGC4F	4 FORKLIFT CYLINDERS	1	kg	990	780	760
	PSGC8F-FP	PSGC8F	8 FORKLIFT CYLINDERS	2	kg	1920	780	760
	PSGC16F-FP	PSGC16F	16 FORKLIFT CYLINDERS	2	kg	1920	1520	760
	PSGC9V-FP	PSGC9V	9 G-SIZED CYLINDERS	1	kg	1920	780	760
	PSGC18V-FP	PSGC18V	18 G-SIZED CYLINDERS	1	kg	1920	1520	760
	PSGC8F9V-FP	PSGC8F9V	8 FORKLIFT / 9 G-SIZED CYLINDERS	3	kg	1920	1520	760
-		PSGC-29L	PRATT GAS CAGE SHELF LARGE	-	kg	-	-	-
-		PSGC-29S	PRATT GAS CAGE SHELF SMALL	-	kg	-	-	-

Note: 1. The storage of cylinders should preferably be located out-of-doors in a well ventilated area away from any flame, heat or other ignition sources. 2. All cylinders must be stored vertically in accordance with the Australian standards and secured with chains provided. 3. Aerosol qtys based on diameter of 68mm & loose containers (not packaged cartons). 4. Cylinder qtys based on boc cylinder specifications, this may differ for other manufacturers. For assembled cages allow up to 5 working days.

GAS CYLINDER & AEROSOL CAN STORAGE CAGES

STORAGE OF STANDARD SIZED GAS CYLINDERS:

MODEL	PSGC9V	PSGC18V SIDE 1	PSGC18V SIDE 2	PSGC8F9V SIDE 1	PSGC8F9V SIDE 2
*ALL MEASUREMENTS IN MILLIMETERS	H x W x D	H x W x D	H x W x D	H x W x D	H x W x D
TOTAL EXTERNAL DIMENSIONS	1920 x 785 x 770	1920 x 1524 x 770		1920 x 1525 x 770	
INTERNAL STORAGE AREA OF CAGES : SINGLE LEVEL UPPER LEVEL LOWER LEVEL	1815 x 705 x 720	1815 x 705 x 720		1815 x 705 x 720	925 x 705 x 720 880 x 705 x 720
DOORWAY CLEARANCE	1780 x 700	1780 x 700	1780 x 700	1780 x 700	1780 x 700
FLOOR TO ROOF	1815	1815	1815	1815	

MODEL	PSGC4F	PSGC4F	PSGC16F SIDE 1	PSGC16F SIDE 2	PSGC8F9V SIDE 1	PSGC8F9V SIDE 2
*ALL MEASUREMENTS IN MILLIMETERS	H x W x D	H x W x D	H x W x D	H x W x D	H x W x D	
TOTAL EXTERNAL DIMENSIONS	990 x 780 x 760	1920 x 785 x 770	1920 x 1525 x 770		1920 x 1525 x 770	
INTERNAL STORAGE AREA OF CAGES : SINGLE LEVEL UPPER LEVEL LOWER LEVEL	920 x 705 x 720	925 x 705 x 720 890 x 705 x 720	925 x 705 x 720 890 x 705 x 720	925 x 675 x 720 890 x 675 x 720	1815 x 705 x 720	925 x 705 x 720 880 x 705 x 720

CHEMICAL SEGREGATION CHART



		CLASS 2		CLASS 3		CLASS 4			CLASS 5		CLASS 6		CLASS 8	
COMPRESSED GASES	2	2.1 Flammable		Compatible	KEEP APART	Segregate from	Segregate from	Segregate from	Segregate from	Segregate from	ISOLATE	KEEP APART	KEEP APART	
		2.2 Non-flammable/non-toxic		KEEP APART	Compatible	KEEP APART	Segregation may be necessary	Segregate from	Segregation may be necessary	Segregation may be necessary	Segregate from	Segregation may be necessary	Segregation may be necessary	KEEP APART
FLAMMABLE LIQUIDS (and Combustible liquids)	3		Segregate from	KEEP APART	Compatible	KEEP APART	Segregate from	Segregate from	Segregate from	ISOLATE	KEEP APART	KEEP APART	KEEP APART	
FLAMMABLE SOLIDS	4	4.1 Flammable Solids		Segregate from	Segregation may be necessary	KEEP APART	Compatible	KEEP APART	Segregate from	Segregate from	Segregate from	Segregate from	KEEP APART	Segregation may be necessary
4.2 Spontaneously combustible			Segregate from	Segregate from	Segregate from	KEEP APART	Compatible	KEEP APART	Segregate from	ISOLATE	KEEP APART	KEEP APART	KEEP APART	
4.3 Dangerous when wet			Segregate from	Segregation may be necessary	Segregate from	Segregate from	KEEP APART	Compatible	KEEP APART	Segregate from	Segregation may be necessary	Segregation may be necessary	Segregation may be necessary	
OXIDIZING SUBSTANCES	5	5.1 Oxidizing agents		Segregate from	Segregation may be necessary	Segregate from	Segregate from	Segregate from	KEEP APART	*	Segregate from	KEEP APART	KEEP APART	
5.2 Organic peroxides			ISOLATE	Segregate from	ISOLATE	Segregate from	ISOLATE	Segregate from	Segregate from	Segregate from	Compatible	KEEP APART	KEEP APART	
TOXIC SUBSTANCES	6		KEEP APART	Segregation may be necessary	KEEP APART	KEEP APART	KEEP APART	Segregation may be necessary	KEEP APART	KEEP APART	Compatible	Segregation may be necessary	Segregation may be necessary	
CORROSIVE SUBSTANCES	8		KEEP APART	KEEP APART	KEEP APART	Segregation may be necessary	KEEP APART	Segregation may be necessary	KEEP APART	KEEP APART	Segregation may be necessary	*	*	



Dangerous goods of the same Class should be compatible; consult SDS or suppliers about requirements for individual substances.



Dangerous goods of the same Class could be incompatible or react dangerously. Consult the SDS or suppliers about requirements for individual substances.



Segregation of these Classes may be necessary. Consult the SDS or supplier.



Dangerous goods of these classes should be kept apart by at least 3m. Consult the SDS or supplier.



These combinations of dangerous goods should be segregated by at least 5m and kept in separate compounds or building compartments.



This requirement applies to organic peroxides, for which dedicated stores or storage cabinets are recommended, Adequate separation from other buildings and boundaries is required.

NOTES: 1. In all cases, the SDS or supplier of the goods should be consulted. 2. The segregation of dangerous goods of Division 1.4S may be necessary. Consult the SDS or the supplier of the goods. 3. Combustible liquids shall be segregated in the same manner as flammable liquids of Class 3. 4. Dangerous goods of Class 9 should be segregated in accordance with SDS. 5. If the dangerous goods have a Sub-risk of another Class, then the segregation requirements of the Sub-risk need to be determined and more stringent segregation requirements applied. 6. Where smoke detectors are to be stored, their supplier should be consulted and any specific storage and handling recommendations followed.

"ChemSafe" This information has been created using information and elements from ChemSafe.

CABINET SPARE PARTS

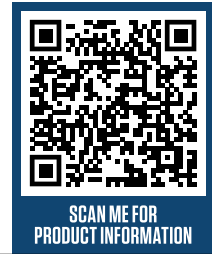

METAL CABINET SPARE PARTS

P/NO	DESCRIPTION
739000	PRATT RECESSED DOOR HANDLE AND KEYS - LATCHING SUITS AS, AST & ASPH CABINETS
739003	PRATT SPARE KEYS - PAIR SUITS AS, AST & ASPH CABINETS
739005	PRATT VENT BUNG CAP ONE ONLY SUITS ALL CABINETS
739027	PRATT RECESSED DOOR HANDLE NON-LATCHING SUITS AOA, APO & AC4 CABINETS
739100	PRATT DOOR LATCH ASSEMBLY KIT SUITS 30L & 100L CABINETS
739101	PRATT DOOR LATCH ASSEMBLY KIT SUITS 60L CABINETS
739102	PRATT DOOR LATCH ASSEMBLY KIT SUITS 160L CABINETS
739103	PRATT DOOR LATCH ASSEMBLY KIT SUITS 250L, 350L & 425L CABINETS
739104	PRATT HYDRAULIC DOOR CLOSURE AND CHASSIS ASSEMBLY KIT SUITS 30L AND 60L CABINETS
739105	PRATT HYDRAULIC DOOR CLOSURE AND CHASSIS ASSEMBLY KIT SUITS 100L CABINETS
739106	PRATT HYDRAULIC DOOR CLOSURE AND CHASSIS ASSEMBLY KIT SUITS 250L AND 425L CABINETS
739107	PRATT HYDRAULIC DOOR CLOSURE AND CHASSIS ASSEMBLY KIT SUITS 160L CABINETS
739108	PRATT HYDRAULIC DOOR CLOSURE AND CHASSIS ASSEMBLY KIT SUITS 350L CABINETS
739109	PRATT HYDRAULIC DOOR CLOSURE AND CHASSIS ASSEMBLY KIT SUITS 30L & 60L COR. CABINETS
739110	PRATT HYDRAULIC DOOR CLOSURE AND CHASSIS ASSEMBLY KIT SUITS 100L CORROSIVE CABINETS
739111	PRATT HYDRAULIC DOOR CLOSURE AND CHASSIS ASSEMBLY KIT SUITS 250L & 425L COR. CABINET
739112	PRATT HYDRAULIC DOOR CLOSURE AND CHASSIS ASSEMBLY KIT SUITS 160L CORROSIVE CABINET
739113	PRATT HYDRAULIC DOOR CLOSURE AND CHASSIS ASSEMBLY KIT SUITS 350L CORROSIVE CABINET
739114	PRATT HYDRAULIC DOOR CLOSURE AND CHASSIS ASSEMBLY KIT SUITS 5560ASE 350L CABINET

POLY CABINET SPARE PARTS

P/NO	DESCRIPTION
738083	PRATT SPARE HANDLE/LATCH AND SPARE KEYS SUITS PSPH CORROSIVE CABINETS
738085	PRATT DOOR HINGES (PAIR) SUITS PSPH CORROSIVE CABINETS

ADDITIONAL SHELVES & TRAYS

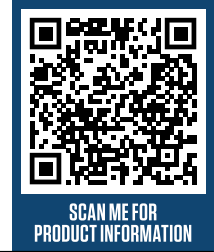

P/NO	DESCRIPTION
5517-29S	PRATT SHELF. SUITS AS, AST, AOA AC4, APO 30L & 60L CABINETS
5535-29S	PRATT SHELF. SUITS AS, AST, AOA AC4, APO 100L CABINETS
5545-29S	PRATT SHELF. SUITS AS, AST, AOA AC4, APO 160L & 250L CABINETS
5560-29S	PRATT SHELF. SUITS AS, AST 350LTR CABINETS
5560E-29S	PRATT SHELF, SUITS AS 1 DOOR 350LTR CABINET
5590-29S	PRATT SHELF, SUITS AS 425LTR CABINET
5517PH-29S	PRATT SHELF. SUITS ASPH 30LTR AND 60LTR CABINETS
5535PH-29S	PRATT SHELF. SUITS ASPH 100LTR CABINETS
5545PH-29S	PRATT SHELF. SUITS ASPH 160LTR & 250LTR CABINETS
5560PH-29S	PRATT SHELF. SUITS ASPH 350LTR CABINETS
5590PH-29S	PRATT SHELF. SUITS ASPH 425LTR CABINETS
5517-29TS	PRATT TRAY. SUITS ASPH 30LTR, 60LTR & 350LTR CABINETS
5535-29TS	PRATT TRAY. SUITS ASPH 100LTR CABINETS
5545-29TS	PRATT TRAY. SUITS ASPH 160LTR, 250LTR, 350LTR & 425LTR CABINETS
5512P-29	PRATT SHELF. SUITS PSPH 20LTR CABINETS
5516P-29	PRATT SHELF. SUITS PSPH 40LTR & 60LTR CABINETS
5535P-29	PRATT SHELF. SUITS PSPH 100LTR CABINETS
5545P-29	PRATT SHELF. SUITS PSPH 160LTR & 250LTR CABINETS



5535-29S



5560-29S



5517PH-29S



5590PH-29S

AUS & NZ
SPILL KITS





THE NINE STEPS TO EMERGENCY SPILL RESPONSE

STEP ONE

ASSESS

Assess risk.

STEP TWO

IDENTIFY

Identify type of material spilled and the source. Use spill identification chart to ensure correct absorbent material is used.

STEP THREE

PROTECT

Protect yourself by wearing the appropriate protective gear for the situation – if the source or the materials are identifiable, assume the worst.

STEP FOUR

CONTAIN

Contain the liquid and seal the drains using booms (snakes).

STEP FIVE

CONTROL

Control the spill by closing valves, rotating punctured drums and plugging leaks where it is possible and safe to do so.

STEP SIX

CLEAN UP

Clean up using absorbent materials.

STEP SEVEN

DISPOSE

Dispose of used absorbents and spilt liquids in accordance with local laws.

STEP EIGHT

DECONTAMINATE

Decontaminate all tools and reusable materials properly before reuse.

STEP NINE

RESTOCK

Restock materials and safety equipment used in any clean-up operation.



FULLY EQUIPPED KITS READY TO HANDLE

**ANY SPILL GREAT
OR SMALL**

SPILL KIT IDENTIFICATION STRUCTURE

PRATT SAFETY SYSTEMS GOAL IS TO SOLVE KEY ISSUES CREATED BY THE LACK OF AN INDUSTRY SPILL STANDARD. THESE INCLUDE:

- On a site where there are coloured bins and/or packs similar to the spill kit (often used for waste or other storage) the recognition of a spill kit would be by reading the label only. This presents difficulty in cases where the labelling is not easily visibly, or English is not easily understood
- Where a spill kit has not been correctly identified, its use on an incompatible fluid can cause safety and environmental risks or non-performance.
- Current spill kit label terminology can vary and be confusing for the user. For example the terms 'General Purpose' and 'Universal' are both used to describe a similar type of spill kit and users often misunderstand when and how these spill kits should be used.

TO OVERCOME THESE PROBLEMS, OUR WHEELIE BIN SPILL KITS WILL HAVE A LIME GREEN BASE WITH INDIVIDUAL BIN APPLICATIONS BEING IDENTIFIED BY THE FOLLOWING NEW LID COLOURS:



THE BENEFITS OF THE IDENTIFICATION STRUCTURE INCLUDE:

- **COLOUR CODING:** Having a recognisable colour for a spill kit with standard labelling enables the user to have more confidence that the right kit had been selected.
- **IMPROVED IDENTIFICATION:** This structure for identifying the purpose or type of a spill kit so that the fluids for which the kit is suitable, are more easily understood by the user, thus removing much of the existing confusion while increasing safety.
- **STANDARDISATION:** By standardising our Pratt Spill Kit range, this brings important emergency response equipment into line with similar standardisation that has been created for Fire Extinguishers, which also have a colour standard for recognition and type.

THE LID COLOURS HAVE BEEN SELECTED TO MATCH THE ABSORBENT COLOURS USED BY MOST SUPPLIERS FOR THE PURPOSES DESCRIBED.

Absorbent materials such as Booms, Pillows and Pads have also been coloured to suit the type of spill application that suits each kit.



HOW TO SELECT A SPILL KIT

AT SOME POINT IN TIME, NEARLY EVERY INDUSTRIAL FACILITY MUST DEAL WITH LEAKS AND SPILLS OF LIQUIDS. IN ORDER TO MINIMISE THE IMPACT THESE SPILLS HAVE ON EQUIPMENT, PERSONNEL, YOUR FACILITY AND THE ENVIRONMENT, YOU MUST HAVE AN ACTION PLAN THAT WILL PREVENT SPILLS FROM POLLUTING SOILS, GROUNDWATER, STORM WATER DRAINS AND WATERWAYS.

Part of that action plan should include a clearly labelled spill kit, located in an easily accessible location. The spill kit should contain items such as absorbent pads, booms, pillows, gloves and disposal bags.

CHOOSING A SPILL KIT:

When choosing a spill kit there are a few questions you need to consider.

THE SIZE AND CAPACITY OF THE SPILL KIT:

Choose a spill kit that enables you to absorb the maximum likely spill, not the total amount of liquid you have. Spill kit absorbency rates quoted by manufacturers are often based on maximum absorbency of very viscous liquids. Allow for this in your calculations - it's possible that you may need to halve the capacity of a spill kit given if you are absorbing a less viscous liquid, like diesel as an example.

THE MATERIALS FROM WHICH THE COMPONENTS ARE MADE FROM:

Manufacturers produce standard kits, however all components can be altered to suit different job requirements. There are generally two types of absorbents - one type absorbs all liquids such as degreasers, coolant, acids, hydrocarbons and water. The other will only absorb hydrocarbons. Determine which liquids may be spilled and then which type of absorbent you require. It may be that you need two types of spill kits.

GENERAL PURPOSE SPILL KITS:

Colour-coded grey and contain grey absorbents. They are ideal for all liquid spills, with the exception of aggressive acids or alkalis.

OIL & FUEL ONLY SPILL KITS:

Colour-coded white and contain white absorbents. They are designed to recover oils and fuels only, in and around water without absorbing the water. If the spill kit will be used for spills on soil rather than hard surfaces or concrete surfaces, choose a kit which includes ground and floor absorbents.

HAZCHEM SPILL KITS:

Colour-coded yellow and contain yellow absorbents. They are designed for acids, alkalis, coolants, paints and oils and fuels and are made from inert material which will not react with any absorbed liquids.



SPILL TYPE IDENTIFICATION CHART

CHOOSE A SPILL KIT TYPE

Select a spill kit that is suitable to the type of spill that is being recovered.

SPILL KIT TYPE	GENERAL PURPOSE	OIL & FUEL ONLY	HAZCHEM
ABSORPTION CAPACITY	240L 120L 75L 50L 25L	240L 120L 75L 50L 25L	240L 120L 75L 50L 25L
COOLANTS & GENERAL LIQUIDS	✓	✗	✓
WATER BASED LIQUIDS	✓	✗	✓
HERBICIDE & PESTICIDE	✓	✗	✓
OIL FUEL & SOLVENTS	✓	✓	✓
ACIDS & CAUSTICS	✗	✗	✓
	ABSORBS WATER	WATER REPELLENT	ABSORBS WATER

SPILL KIT SELECTION CHART

1. CHOOSE AN ABSORBENT TYPE

Select a type that is suitable for the type of spill that is being recovered.

GENERAL PURPOSE

Colour coded grey, will absorb both water and oil based. Best used for indoor spills.

OIL & FUEL ONLY

Colour coded white, absorbing only oil based fluids. These are best used outdoors.

HAZCHEM

Colour coded yellow, this type is used to clean up unknown, corrosive or aggressive hazchem spills. Can be used indoors and out.

2. CHOOSE A SUITABLE FORMAT

Select a format that is suitable of the type of spill that is being recovered.



BOOMS



PILLOWS



PADS



FLOOR SWEEPS

3. CHOOSE A SUITABLE SIZE

Choose the size that suits the likely spill size.



BAG KIT/S



120L BIN



240L BIN

AUS SPILL KITS



AUS GENERAL PURPOSE SPILL KITS

GENERAL PURPOSE SPILL KITS COLOUR CODED GREY FOR UNIVERSAL LIQUID SPILL ABSORPTION.

Ideal for all liquid spills with the exception of aggressive acids or alkalis.

For general industry and non-industry applications. Commonly used in the automotive, industrial, commercial markets, warehousing, waste management and manufacturing industries.

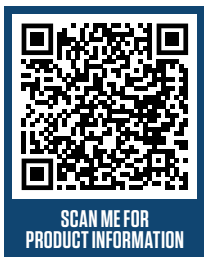

P/NO: ESKGP240



P/NO: ESKGP120



P/NO: ESKGP075



P/NO: ESKGP050



P/NO: ESKGP025

CONTENTS	SIZE	P/NO	240L	120L	75L	50L	25L
GENERAL PURPOSE FLOOR SWEEP	30L	FSGP30	3	2	-	-	-
GENERAL PURPOSE FLOOR SWEEP	15L	FSGP15	-	-	1	1	-
GREY GENERAL PURPOSE BOOM	1.2m	BG420	2	2	2	2	1
GREY GENERAL PURPOSE BOOM	2.4m	BG840	2	-	-	-	-
GREY GENERAL PURPOSE PILLOW	420g	PG420	2	2	1	-	-
DUST PAN AND BRUSH SET	-	DPBS	1	1	1	1	-
GREY GENERAL PURPOSE ABSORBENT PAD 10 PACK	300GSM	APG300	4	3	2	1	1
CONTAMINATED WASTE BAG	900x600mm	SK-CWB	5	5	3	2	1
GREEN NITRILE GLOVES	XL	SK-RNF15XL	2	2	1	1	1

NOTE: FOR CURRENT SPILL KIT CONTENTS, PLEASE REFER TO OUR WEBSITE. ALL KITS COME WITH RELATIVE BINS/BAGS.

AUS OIL & FUEL ONLY SPILL KITS

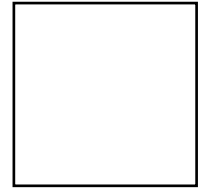

OIL & FUEL ONLY SPILL KITS COLOUR CODED WHITE FOR HYDROCARBON SPILL ABSORPTION.

Oil & Fuel Only absorbents take on board hydrocarbon liquids such as fuel, petrol, diesel, oil, solvents.

Additionally, they are designed to repel water making them ideal for oil & fuel spill recovery on either land or water.

For general industry and non-industry applications.



P/NO: ESKOF240



P/NO: ESKOF120



P/NO: ESKOF075



P/NO: ESKOF050



P/NO: ESKOF025

CONTENTS	SIZE	P/NO	240L	120L	75L	50L	25L
GENERAL PURPOSE FLOOR SWEEP	30L	FSGP30	3	2	-	-	-
GENERAL PURPOSE FLOOR SWEEP	15L	FSGP15	-	-	1	1	-
WHITE OIL & FUEL ONLY BOOM	1.2M	BW420	2	2	2	2	1
WHITE OIL & FUEL ONLY BOOM	2.4M	BW840	2	-	-	-	-
WHITE OIL & FUEL ONLY PILLOW	420G	PW420	2	2	1	-	-
DUST PAN AND BRUSH SET	-	DPBS	1	1	1	1	-
WHITE OIL & FUEL ONLY ABSORBENT PAD 10 PACK	300GSM	APW300	4	3	2	1	1
CONTAMINATED WASTE BAG	900x600mm	SK-CWB	5	5	3	2	1
GREEN NITRILE GLOVES	XL	SK-RNF15XL	2	2	1	1	1

NOTE: FOR CURRENT SPILL KIT CONTENTS, PLEASE REFER TO OUR WEBSITE. ALL KITS COME WITH RELATIVE BINS/BAGS.

AUS HAZCHEM SPILL KITS



HAZCHEM SPILL KITS COLOUR CODED YELLOW FOR HAZCHEM LIQUID SPILL ABSORPTION.

Designed for acids, alkalis, coolants, paints and oils and fuels and are made from inert material which will not react with any absorbed liquids.

For general industry and non-industry applications.



P/NO: ESKH240

P/NO: ESKH120

P/NO: ESKH075

P/NO: ESKH050

P/NO: ESKH025

CONTENTS	SIZE	P/NO	240L	120L	75L	50L	25L
ZEOLITE FLOOR SWEEP	15L	FSZ15	6	2	2	1	-
YELLOW HAZCHEM BOOM	1.2M	BY420	2	2	2	2	1
YELLOW HAZCHEM BOOM	2.4M	BY840	2	-	-	-	-
YELLOW HAZCHEM PILLOW	420G	PY420	2	2	1	-	-
DUST PAN AND BRUSH SET	-	DPBS	1	1	1	1	-
YELLOW HAZCHEM ABSORBENT PAD 10 PACK	300GSM	APY300	4	5	2	1	1
CONTAMINATED WASTE BAG	900x600mm	SK-CWB	5	5	3	2	1
GREEN NITRILE GLOVES	XL	SK-RNF15XL	2	2	1	1	1

NOTE: FOR CURRENT SPILL KIT CONTENTS, PLEASE REFER TO OUR WEBSITE. ALL KITS COME WITH RELATIVE BINS/BAGS.

AUS LIGHT VEHICLE KITS



PRATT LIGHT VEHICLE SPILL KITS CAN BE EASILY STORED IN YOUR VEHICLE AND ARE MOBILE FOR ANY WORKSITE. THEY ARE IDEAL FOR SPILLS WHICH REQUIRE A QUICK RESPONSE.



P/NO: SKGP025



P/NO: SKOF025



P/NO: SKH025

CONTENTS	SIZE	P/NO	AMT
GENERAL PURPOSE FLOOR SWEEP	15L	FSGP15	1
GREY GENERAL PURPOSE BOOM	1.2m	BG420	1
GREY GENERAL PURPOSE ABSORBENT PAD 10 PACK	300GSM	APG300	1
CONTAMINATED WASTE BAG	900x 600mm	SK-CWB	2
GREEN NITRILE GLOVES	XL	SK-RNF15XL	1

CONTENTS	SIZE	P/NO	AMT
GENERAL PURPOSE FLOOR SWEEP	15L	FSGP15	1
WHITE OIL & FUEL ONLY BOOM	1.2m	BW420	1
WHITE OIL & FUEL ONLY ABSORBENT PAD 10 PACK	300GSM	APW300	1
CONTAMINATED WASTE BAG	900x 600mm	SK-CWB	2
GREEN NITRILE GLOVES	XL	SK-RNF15XL	1

CONTENTS	SIZE	P/NO	AMT
ZEOLITE FLOOR SWEEP	15L	FSZ15	1
YELLOW HAZCHEM BOOM	1.2m	BY420	1
YELLOW HAZCHEM ABSORBENT PAD 10 PACK	300GSM	APY300	1
CONTAMINATED WASTE BAG	900x 600mm	SK-CWB	2
GREEN NITRILE GLOVES	XL	SK-RNF15XL	1

NOTE: FOR CURRENT SPILL KIT CONTENTS, PLEASE REFER TO OUR WEBSITE. ALL KITS COME WITH RELATIVE BINS/BAGS.



AUS LIGHT VEHICLE KITS ARE IDEAL
FOR QUICK RESPONSE

NZ ONLY SPILL KITS



NZ ONLY GENERAL PURPOSE SPILL KITS

GENERAL PURPOSE SPILL KITS COLOUR CODED GREY FOR UNIVERSAL LIQUID SPILL ABSORPTION.

Ideal for all liquid spills with the exception of aggressive acids or alkalis.

For general industry and non-industry applications. Commonly used in the automotive, industrial, commercial markets, warehousing, waste management and manufacturing industries.

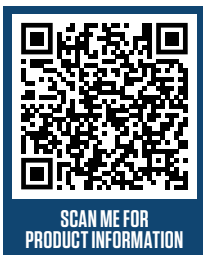

P/N: NZSKGP240



P/N: NZSKGP120



P/N: NZSKGP050



P/N: NZSKGP025

CONTENTS	SIZE	P/NO	240L	120L	50L	25L
GREY GENERAL PURPOSE ABSORBENT PAD 10 PACK	-	APG300	6	3	2	1
GREY GENERAL PURPOSE BOOM	1.2m	BG420	2	2	2	2
GREY GENERAL PURPOSE BOOM	2.4m	BG840	2	-	-	-
GREY GENERAL PURPOSE PILLOW	-	PG420	6	1	2	-
GENERAL PURPOSE FLOOR SWEEP	15L	FSGP15	3	2	-	-
GENERAL PURPOSE FLOOR SWEEP	30L	FSGP30	3	2	-	-
CONTAMINATED WASTE BAG	-	SK-CWB	4	4	2	2
DUST PAN AND BRUSH SET	-	DPBS	1	1	-	-

NOTE:
FOR CURRENT SPILL KIT CONTENTS, PLEASE REFER TO OUR WEBSITE. ALL KITS COME WITH RELATIVE BINS/BAGS.

NZ ONLY OIL & FUEL SPILL KITS

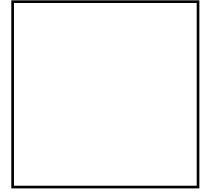

OIL & FUEL ONLY SPILL KITS COLOUR CODED WHITE FOR HYDROCARBON SPILL ABSORPTION.

Oil & Fuel Only absorbents take on board hydrocarbon liquids such as fuel, petrol, diesel, oil, solvents.

Additionally, they are designed to repel water making them ideal for oil & fuel spill recovery on either land or water.

For general industry and non-industry applications.



P/N: NZSKOF240



P/N: NZSKOF120



P/N: NZSKOF050



P/N: NZSKOF025

CONTENTS	SIZE	P/NO	240L	120L	50L	25L
WHITE OIL & FUEL ONLY ABSORBENT PAD 10 PACK	-	APW300	6	3	2	1
WHITE OIL & FUEL ONLY BOOM	1.2m	BW420	3	2	2	2
WHITE OIL & FUEL ONLY BOOM	2.4m	BW840	3	-	-	-
WHITE OIL & FUEL ONLY PILLOW	-	PW420	3	1	2	-
GENERAL PURPOSE FLOOR SWEEP	15L	FSGP15	3	2	-	-
GENERAL PURPOSE FLOOR SWEEP	30L	FSGP30	3	2	-	-
CONTAMINATED WASTE BAG	-	SK-CWB	4	2	2	2
DUST PAN AND BRUSH SET	-	DPBS	1	1	-	-
NITRILE GLOVES	-	SK-RNF15L	1	1	1	1

NOTE: FOR CURRENT SPILL KIT CONTENTS, PLEASE REFER TO OUR WEBSITE. ALL KITS COME WITH RELATIVE BINS/BAGS.

NZ ONLY HAZCHEM SPILL KITS

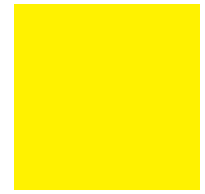

HAZCHEM SPILL KITS COLOUR CODED YELLOW FOR HAZCHEM LIQUID SPILL ABSORPTION.

Designed for acids, alkalis, coolants, paints and oils and fuels and are made from inert material which will not react with any absorbed liquids.

For general industry and non-industry applications.

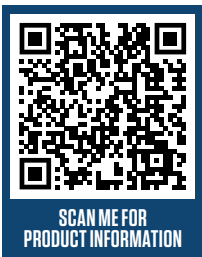

P/NO: NZSKH240



P/NO: NZSKH120



P/NO: NZSKH050



P/NO: NZSKH025

CONTENTS	SIZE	P/NO	240L	120L	50L	25L
YELLOW HAZCHEM ABSORBENT PAD 10 PACK		APY300	7	3	2	1
YELLOW HAZCHEM BOOM	1.2M	BY420	3	2	2	2
YELLOW HAZCHEM BOOM	2.4M	BY840	3	-	-	-
YELLOW HAZCHEM PILLOW		PY420	3	1	2	-
ZEOLITE FLOOR SWEEP	15	FSZ15	8	6	0	0
CONTAMINATED WASTE BAG	-	SK-CWB	5	5	1	1
DUST PAN AND BRUSH SET	-	DPBS	1	1	-	-
NITRILE GLOVES	-	SK-RNF15L	1	1	1	1

NOTE: FOR CURRENT SPILL KIT CONTENTS, PLEASE REFER TO OUR WEBSITE. ALL KITS COME WITH RELATIVE BINS/BAGS.

ABSORBENT MATERIALS



HOW ARE SPILLS ABSORBED? BY USING ABSORBENT MATERIAL. IN EACH SPILL KIT THERE ARE MULTIPLE METHODS AVAILABLE TO CONTAIN ANY SPILL NO MATTER THE SIZE. USING ABSORBENT MATERIALS ENSURES THAT THE SPILL IS CLEANED UP EFFECTIVELY, EFFICIENTLY, AND PROPERLY DISPOSED OF.

Each item of absorbent material has its own specific use when dealing with a spill, these are:

- Booms – Ideal for blocking drains, containing a spill before it spreads or pollutes the environment and waterways.
- Pads – Used to wipe tools and collect smaller spills that still pose a risk to the workplace.
- Pillows – Quickly soak a large amount of liquid. Able to be squeezed and reused.
- Floor Sweeps – Lightweight and easy to spread. Floor sweep can be used indoors and outdoors, on any surface including concrete and dirt, and in some cases, water.

ABSORBENT BOOMS

GENERAL PURPOSE | OIL & FUEL ONLY | HAZCHEM

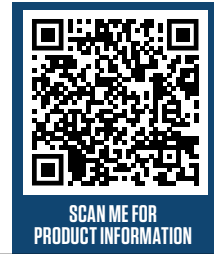

ABSORBENT BOOMS ARE FLEXIBLE TUBES USED TO CONTAIN AND CLEAN-UP SPILLED FLUIDS. BOOMS ARE WIDELY USED IN INDUSTRIAL APPLICATIONS AND ARE IDEAL FOR SPILL KITS. FAST SPREADING SPILLS ARE QUICKLY STOPPED WITH A BOOM. OUR FULL LINE OF BOOMS ALL HAVE POLYPROPYLENE SLEEVES AND CONTAIN THE QUALITY, 100% POLYPROPYLENE FILL.

General purpose booms are offered in grey. Oil & fuel only booms are available in white. Hazardous material spills should be tackled with our yellow hazchem boom.

INSTRUCTIONS OF USE

- STEP 1:** Place booms around spill to prevent further spread.
- STEP 2:** Overlap booms by 5cm to eliminate gaps. For uneven surfaces, step on sock to ensure seal.
- STEP 3:** Use pillows to absorb collected liquid or to plug drains.

GENERAL PURPOSE ABSORBENT BOOMS

General Purpose Boom colour coded grey for universal liquid spill absorption. Ideal for all liquid spills with the exception of aggressive acids or alkalis. For general industry and non-industry applications.

- Universal fluid absorption.
- Dimensions:
BG420 – L:1.2M x W:7.6cm.
BG840 – L:2.4M x W:7.6cm.



P/NO: BG420/BG840

OIL & FUEL ONLY ABSORBENT BOOMS

Oil & Fuel Only Boom colour coded white for hydrocarbon spill absorption. Oil & Fuel Only absorbents take on board fuel, petrol, diesel, oil, solvents. Additionally, they are designed to repel water. For general industry and non-industry applications.

- Oil & Fuel Only fluid absorption.
- Dimensions:
BW420 – L:1.2M x W:7.6cm.
BW840 – L:2.4M x W:7.6cm.



P/NO: BW420/BW840

HAZCHEM ABSORBENT BOOMS

Hazchem Boom colour coded yellow for hazchem liquid spill absorption. Designed for acids, alkalis, coolants, paints and oils and fuels and are made from inert material which will not react with any absorbed liquids. For general industry and non-industry applications.

- Chemical fluid absorption.
- Dimensions:
BY420 – L:1.2M x W:7.6cm.
BY840 – L:2.4M x W:7.6cm.



P/NO: BY420/BY840

P/NO	MATERIAL	COLOUR	DIMENSIONS	PACKAGE QTY	WEIGHT
BG420	Polypropylene, Cotton 420g/pc	GREY	L:1.2M x W:7.6cm	12pcs/bag	5kg/bag
BG840	Polypropylene, Cotton 840g/pc	GREY	L:2.4M x W:7.6cm	6pcs/bag	5kg/bag
BW420	Polypropylene, 420g/pc	WHITE	L:1.2M x W:7.6cm	12pcs/bag	5kg/bag
BW840	Polypropylene, 840g/pc	WHITE	L:2.4M x W:7.6cm	6pcs/bag	5kg/bag
BY420	Polypropylene, 420g/pc	YELLOW	L:1.2M x W:7.6cm	12pcs/bag	5kg/bag
BY840	Polypropylene, 840g/pc	YELLOW	L:2.4M x W:7.6cm	6pcs/bag	5kg/bag

ABSORBENT PILLOWS

GENERAL PURPOSE | OIL & FUEL ONLY | HAZCHEM

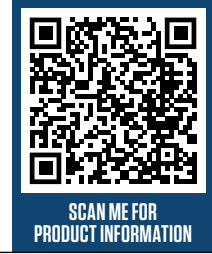

ABSORBENT PILLOWS ARE USED TO CONTAIN LEAKS AND CONSTANT DRIPS THAT ARE TOO LARGE FOR AN ABSORBENT PAD.

Pillows absorb large quantities of spilled fluids, shortening your spill response time. Pillows are ideal for tight spaces under leaky equipment and drums. Our full line of pillows all have a strong, lint-free spun bond outer layer and contain quality 100% polypropylene fill.

General Purpose Pillows are offered in grey. Oil and Fuel Only Pillows are available in white. Hazardous material spills should be tackled with our yellow Hazchem Pillows.

INSTRUCTIONS OF USE

- STEP 1:** Place booms around spill to prevent further spread.
- STEP 2:** Overlap boom by 5cm to eliminate gaps. For uneven surfaces, step on sock to ensure seal.
- STEP 3:** Use pillows to absorb collected liquid or to plug drains.

GENERAL PURPOSE ABSORBENT PILLOWS

General Purpose Pillow colour coded grey for universal liquid spill absorption. Ideal for all liquid spills with the exception of aggressive acids or alkalis. For general industry and non-industry applications.

- Universal fluid absorption.
- Dimensions: L:46cm x W:44cm.

OIL & FUEL ONLY ABSORBENT PILLOWS

Oil & Fuel Only Pillow colour coded white for hydrocarbon spill absorption. Oil & Fuel Only absorbents take on board hydrocarbon liquids such as fuel, petrol, diesel, oil, solvents. Additionally, they are designed to repel water making them ideal for oil & fuel spill recovery on either land or water. For general industry and non-industry applications.

- Oil & Fuel Only fluid absorption.
- Dimensions: L:46cm x W:44cm.

HAZCHEM ABSORBENT PILLOWS

Hazchem Pillow colour coded yellow for hazchem liquid spill absorption. Designed for acids, alkalis, coolants, paints and oils and fuels and are made from inert material which will not react with any absorbed liquids. For general industry and non-industry applications.

- Chemical fluid absorption.
- Dimensions: L:46cm x W:44cm.



P/NO: PG420



P/NO: PW420



P/NO: PY420

P/NO	MATERIAL	COLOUR	DIMENSIONS	PACKAGE QTY	WEIGHT
PG420	Polypropylene, Cotton 420g/pc	GREY	L:46cm x W:44cm	10pcs/bag	4.2kg/bag
PW420	Polypropylene, 420g/pc	WHITE	L:46cm x W:44cm	10pcs/bag	4.2kg/bag
PY420	Polypropylene, 420g/pc	YELLOW	L:46cm x W:44cm	10pcs/bag	4.2kg/bag

ABSORBENT PADS

GENERAL PURPOSE | OIL & FUEL ONLY | HAZCHEM

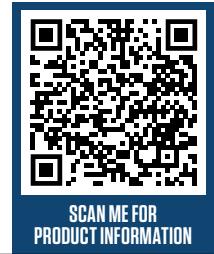

ABSORBENT PADS ARE MADE FROM POLYPROPYLENE FIBERS AND ARE THE MOST POPULAR FORM OF ABSORBENTS.

The Pratt spill range offers various types of absorbent pads for different liquids and site applications. The most widely used Absorbent Pads are General Purpose (grey), Oil & Fuel Only (white) and Hazchem (yellow).

Pads are great for spills on water or land, absorbing many times their own weight in recovered liquid.

INSTRUCTIONS OF USE

- STEP 1:** Place suitable number of pads on spill for immediate absorption.
- STEP 2:** Remove pads carefully, as all pads tend to over saturate and will drip liquid.
- STEP 3:** Place a layer of Floor Sweep, or an extra pad, in the bottom of the waste bag, to absorb any free liquid.

GENERAL PURPOSE ABSORBENT PADS

General Purpose Pad colour coded grey for universal liquid spill absorption. Ideal for all liquid spills with the exception of aggressive acids or alkalis. For general industry and non-industry applications.

- Heavy weight absorbency.
- Universal fluid absorption.
- Perforated on Centerline in Length.
- Dimensions: L:48cm x W:43cm.

OIL & FUEL ONLY ABSORBENT PADS

Oil & Fuel Only Pad colour coded white for hydrocarbon spill absorption. Oil & Fuel Only absorbents take on board hydrocarbon liquids such as fuel, petrol, diesel, oil, solvents. Additionally, they are designed to repel water making them ideal for oil & fuel spill recovery on either land or water. For general industry and non-industry applications.

- Heavy weight absorbency.
- Oil & Fuel Only fluid absorption.
- Perforated on Centerline in Length.
- Dimensions: L:48cm x W:43cm.

HAZCHEM ABSORBENT PADS

Hazchem Pad colour coded yellow for hazchem liquid spill absorption. Designed for acids, alkalis, coolants, paints and oils and fuels and are made from inert material which will not react with any absorbed liquids. For general industry and non-industry applications.

- Heavy weight absorbency.
- Chemical fluid absorption.
- Perforated on Centerline in Length.
- Dimensions: L:48cm x W:43cm.



P/NO: APG300



P/NO: APW300



P/NO: APY300

P/NO	MATERIAL	COLOUR	DIMENSIONS	PACKAGE QTY	WEIGHT
APG300	Polypropylene, 300g/m2	GREY	L:48cm x W:43cm	100pcs/bag	0.62kg/bag
APW300	Polypropylene, 300g/m2	WHITE	L:48cm x W:43cm	100pcs/bag	0.62kg/bag
APY300	Polypropylene, 300g/m2	YELLOW	L:48cm x W:43cm	100pcs/bag	0.62kg/bag

FLOOR SWEEPS



FLOOR SWEEPS ARE A SIMPLE SOLUTION TO ANY SPILL CONTROL NEEDS. AVAILABLE IN A RANGE OF SIZES, FLOOR SWEEPS ARE LIGHTWEIGHT AND EASILY ACCESSIBLE.

Ground to a light crumb like substance that is easy to spread over a large area, or take a small handful and absorb a minor spill if needed. Due to its minuscule nature, Floor Sweeps are perfect for collecting liquid from all surfaces smooth and rough, including concrete, bitumen and dirt.

Available in:

- General Purpose – Universal, for use with most spillage.
- Organic – For use with most liquid spills- including, mild acids and caustics, oil & fuel, body fluids, paint and resins.
- Zeolite – For use with hazchem spills.

FLOOR SWEEP

GENERAL PURPOSE | OIL & FUEL ONLY | HAZCHEM

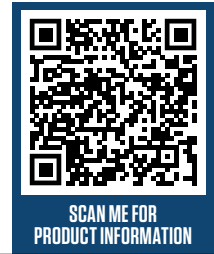

PRATT FLOOR SWEEP FOR USE WITH SPILLS. VERSATILE ENOUGH TO ABSORB MOST LIQUID SPILLS INCLUDING CHEMICAL, PETROLEUM AND TOXIC SPILLAGE. ALL NATURAL, NON TOXIC. SHOULD NOT BE USED ON STRONG ACID OR ALKALINE SOLUTIONS.



INSTRUCTIONS OF USE

- STEP 1:** Liberally spread Pratt Floor Sweep over affected area.
- STEP 2:** Firmly brush to effectively absorb all liquid.
- STEP 3:** Dispose of used absorbents and spill liquids in accordance with local laws.

GENERAL PURPOSE FLOOR SWEEP 15L / 30L

Pratt General Purpose Floor Sweep is manufactured from a special selection of organic cellulose products. These naturally occurring fibrous materials are blended, dried and densified, and they can quickly absorb a wide variety of liquid including petroleum, oils, fuels, solvents, cooking oils, sewage, protein fluids and other messy liquids that could pollute or contaminate the work area and the environment.

These absorbents however, should not be used on strong acid or alkaline solutions. Because of its strong "wicking effect" it is able to rapidly encapsulate liquids so that they cannot leach back into the environment. In many regions, Pratt General Purpose Floor Sweep can be disposed of to landfill, however this is subject to local regulations.

- Highly absorbent, biodegradable, environmentally friendly materials.
- Rapidly encapsulates hydrocarbons (oils, fuels, grease etc) & many other liquids.
- Light weight, easy to apply, simple to use.
- Made of all natural, cellulose materials.
- Does not contain crystalline silica (classified group 1: carcinogenic to humans).
- A solution combining cleaning and spill control in one effective treatment system.
- Safe to use on all surfaces. (as FSGP contains natural fibres, it may stain pale surfaces when mixed with liquid).
- Ideal for domestic, commercial and industrial applications.
- Available in 5kg and 10kg bags.



P/NO: FSGP15



P/NO: FSGP30

P/NO	MATERIAL	BAG CAPACITY	DIMENSIONS	WEIGHT
FSGP15	CELLULOSE MATERIAL	15L/bag	L:50cm X W:38cm	5kg/bag
FSGP30	CELLULOSE MATERIAL	30L/bag	L:66cm X W:51cm	10kg/bag

ORGANIC FLOOR SWEEPS

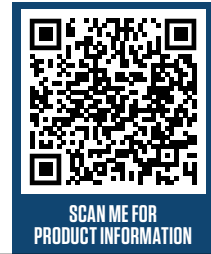

SPILL FIX ORGANIC FLOOR SWEEP FOR USE WITH SPILLS. VERSATILE ENOUGH TO ABSORB MOST LIQUID SPILLS INCLUDING MILD ACIDS AND CAUSTICS, OIL & FUEL, BODY FLUIDS, PAINT AND RESINS.



INSTRUCTIONS OF USE

- STEP 1:** Liberally spread Organic Floor Sweep over affected area.
- STEP 2:** Firmly brush to effectively absorb all liquid.
- STEP 3:** Dispose of used absorbents and spilt liquids in accordance with local laws.

SPILL FIX ORGANIC FLOOR SWEEP ALL PURPOSE 50L

SpillFix is a highly stable absorbent that is suitable for use in a tremendously wide range of hazardous and non-hazardous liquid spill applications. SpillFix Industrial Organic Absorbent is classified as a not readily combustible solid material.

- All natural, organic and light-weight.
- Non-carcinogenic and non-toxic.
- Dust-free.
- Fast, easy to use and cleans on contact.
- Highly absorbent.
- Leaves no slippery residue.
- Works faster, making spill surface safer, quicker.
- Nonabrasive, won't damage floors and equipment.
- Non-hazardous landfill safe.*

All Purpose Absorbent Rapidly Absorbs:

- Fuels and Lubricants.
- All Automotive Fluids.
- Mild Acids and caustics.
- Cooking Oils and Grease.
- Detergent & Softeners.
- Milk and Soft Drink.
- Juices and Syrups.
- Sauces and Salad Dressing.
- Blood and Body Fluids.
- Paint, Chemicals and Resins.

SpillFix is certified safe around food and has the Nonfood Compounds Program listing (J1)#152371. This makes it one of the only industrial absorbents that can be safely recommended for use in commercial and domestic kitchens alike.

*Refer to local authorities for more details.



P/NO: FSAP50

P/NO	MATERIAL	BAG CAPACITY	DIMENSIONS	WEIGHT
FSAP50	NATURAL COIR FIBER PITH	50L/bag	L:60cm x W:38cm x D:14cm	9kg/bag

ZEOLITE FLOOR SWEEP



SCAN ME FOR
PRODUCT INFORMATION

ZEOLITE IS A MINERAL-BASED UNIVERSAL ABSORBENT USED TO REMOVE ALL LIQUID SPILLS FROM HARD SURFACES SUCH AS CONCRETE AND BITUMEN. IT IS IDEAL WHEN SURFACES ARE WEATHERED AND POROUS. USE ZEOLITE FLOOR SWEEP IN WINDY CONDITIONS WHEN A HEAVY, GRANULAR ABSORBENT IS REQUIRED.



INSTRUCTIONS OF USE

- STEP 1:** Liberally spread Pratt Zeolite Floor Sweep over affected area.
- STEP 2:** Firmly brush to effectively absorb all liquid.
- STEP 3:** Dispose of used absorbents and spilt liquids in accordance with local laws.

ZEOLITE FLOOR SWEEP 15L

Zeolite is a mineral-based universal absorbent used to remove all liquid spills from hard surfaces such as concrete and bitumen. It is ideal when surfaces are weathered and porous. Use Zeolite Floor Sweep in windy conditions when a heavy, granular absorbent is required. Natural Zeolite can successfully absorb spills of oil, fuel, coolants, paints, degreaser, and mild acid. In addition, it eliminates odors and toxic vapors caused by spills on contact. Also, Zeolite has a strong framework and unlike clay products, does not break down when saturated

- All natural heat sterilised mineral – contains no chemicals.
- Exceeds EPA landfill leachate tests.
- Absorbs immediately on contact.
- Super absorbent capacity.
- It will not leach back absorbed fluids – ecologically safe.
- Maintains strength integrity when fully absorbed reduces slippage and makes clean-up easy.
- Natural bonding action of zeolite makes it far more active in the absorption process.
- Particle size gradation designed to maximise absorption and minimise floor residue.
- De-Dusted to reduce surface bogging and improves handling.
- Strong wicking action to pull spills from the surface.



P/NO: FSZ15

P/NO	MATERIAL	BAG CAPACITY	DIMENSIONS	WEIGHT
FSZ15	ABSORBENT ZEOLITE GRANULES	15L/bag	L:50cm x W:34cm x D:8cm	9.5kg/bag

SPILL KIT ACCESSORIES



EACH PRATT SPILL KIT COMES WITH VARIOUS ACCESSORIES AS STAPLE EXTRAS DEPENDING ON KIT SIZE. INCLUDING CONTAMINATED WASTE BAG, NITRILE CHEMICAL GLOVES, DUST PAN AND BRUSH, BARRICADE TAPE, SAFETY TAG AND BIN LID COVERS.

*Additional PPE accessories also available that aren't supplied as standard. Refer to page 89

SPILL KIT COMPONENTS & ACCESSORIES



SPILL KIT BIN COVER

P/NO	DESCRIPTION	SIZE
BC240G	GENERAL PURPOSE SPILL KIT BIN COVER - GREY	240L
BC120G	GENERAL PURPOSE SPILL KIT BIN COVER - GREY	120L
BC240W	OIL & FUEL ONLY SPILL KIT BIN COVER - WHITE	240L
BC120W	OIL & FUEL ONLY SPILL KIT BIN COVER - WHITE	120L
BC240Y	HAZCHEM SPILL KIT BIN COVER - YELLOW	240L
BC120Y	HAZCHEM SPILL KIT BIN COVER - YELLOW	120L



P/NO: BC(SIZE)(COLOUR)

COMPONENTS

P/NO	DESCRIPTION	SIZE
CWB	CONTAMINATED WASTE BAG	900X600MM
DPBS	DUST PAN AND BRUSH SET	-
ST112575	SAFETY TAG	125X75MM
CT10075	BARRICADE TAPE	100MX75MM



P/NO: CWB

PPE ACCESSORIES COVERALLS

P/NO	DESCRIPTION
DOWT(SIZE)	DISPOSABLE PROVEK TYPE 4/5/6 DISPOSABLE COVERALL LE COVERALLS
DOOSMS(SIZE)	SMS DISPOSABLE COVERALLS
DOWP(SIZE)	PROVEK™ DISPOSABLE COVERALLS



P/NO: DOWT

RESPIRATORY PROTECTION

P/NO	DESCRIPTION	SIZE
HMABEK1P2-HP	CHEMICAL RESPIRATOR KIT - BUCKET	OSFA
HMA1P2-HP	TRADIES RESPIRATOR KIT - BUCKET	OSFA
PC823	PROMESH® RESPIRATOR P2 (CARBON FILTER)	OSFA
PC321	RESPIRATOR P2 WITH VALVE	OSFA
PCFFP2V	RESPIRATOR P2 WITH VALVE (HORIZONTAL FLAT FOLD)	OSFA



P/NO:PC321

HAND PROTECTION

P/NO	DESCRIPTION
RNF15(SIZE)	NITRILE CHEMICAL GLOVES
NPUPC (SIZE)	PROCHEM GLOVES
BK (SIZE)	BLACK KNIGHT® LATEX GLOVES
NEO (SIZE)	BLACK NEOPRENE GLOVES
PVC45DD	GREEN PVC GLOVES - LONG DOUBLE DIPPED
MDNPFHD (SIZE)	BLACK EXTRA HEAVY DUTY NITRILE



P/NO: NPUPC

PROTECTIVE EYEWEAR

P/NO	DESCRIPTION	SIZE
1600	TSUNAMI - CLEAR	OSFA
3000	VISITORS SAFETY GLASSES CLEAR LENS	OSFA
3700	3700 SERIES - CLEAR GOGGLE	OSFA



P/NO: 1600

SPILL CONTAINMENT

**CHEMICALS OR HAZARDOUS
SUBSTANCES STORAGE.**

**WHEREVER CHEMICALS OR HAZARDOUS
SUBSTANCES ARE BEING STORED, HANDLED
OR TRANSPORTED, IT IS ESSENTIAL THAT ALL
APPROPRIATE MEASURES ARE IN PLACE FOR
THE CONTAINMENT OF THESE CHEMICALS/
SUBSTANCES IN THE EVENT OF A SPILL
OR LEAK.**

Pratt's extensive product range and wealth of experience ensures that we are able to provide our customers with a range of containment solutions to meet any need.



WALULA



SPILL PALLET

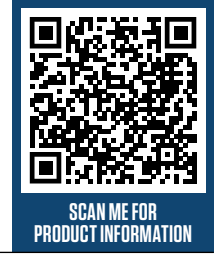

BUILT FOR HEAVY LOADS AND CONVENIENT HANDLING

- High load capacity
- 100% polyethylene construction
- Compatible with a broad range of chemicals including acids, corrosives, fuels and oils
- Nestable design allowing multiple pallets to be shipped or stored.
- Removable grate allows easy access to clean bund sump
- Forkliftable

1011
PRATT SPILL PALLET STANDARD 2 DRUM



1235
PRATT SPILL PALLET STANDARD 4 DRUM



P/NO	HEIGHT(MM)	WIDTH(MM)	DEPTH(MM)	WEIGHT(KG)	SUMP(L)	UDL(KG)
1011	430	1320	660	21	260	1136
1235	300	1300	1300	36	250	3000

LOW PROFILE SPILL DECKS



SCAN ME FOR
PRODUCT INFORMATION

COMPATIBLE WITH A BROAD RANGE OF CHEMICALS INCLUDING ACIDS, CORROSIVES, FUELS AND OILS

- 100% polyethylene construction
- Forkliftable
- Removable grate allows easy access to clean bund sump
- Nestable design allowing multiple pallets to be shipped or stored.

1321
PRATT SPILL DECK 1 DRUM



1086
PRATT SPILL DECK 2 DRUM



1072
PRATT SPILL DECK 4 DRUM



P/NO	HEIGHT(MM)	WIDTH(MM)	DEPTH(MM)	WEIGHT(KG)	SUMP(L)	UDL(KG)
1321	150	680	680	5.5	42	700
1086	150	1300	680	17	82	1500
1072	150	1300	1300	32	165	3000

IBC SPILL PALLETS

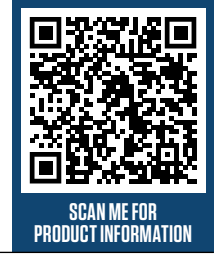

ECONOMICAL AND PORTABLE CONTAINMENT FOR IBCS

- Suitable for intermediate bulk containers (IBCs), drums or other large vessels. All substances stored must be compatible.
- 100% polyethylene construction
- Forkliftable
- Removable grate allows easy access to clean bund sump
- Built for heavy loads and convenient handling
- High load capacity
- Australian Made

1158
PRATT IBC SPILL PALLET 1 TANK



1144
PRATT IBC SPILL PALLET TWIN SIDE BY SIDE 2 TANK

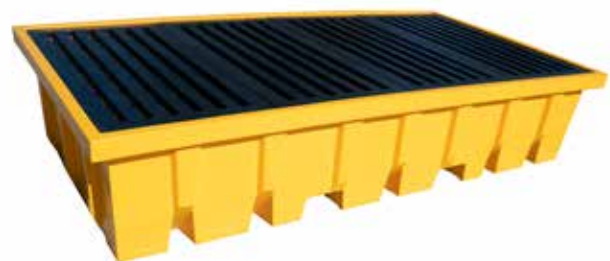

P/NO	HEIGHT(MM)	WIDTH(MM)	DEPTH(MM)	WEIGHT(KG)	SUMP(L)
1158	660	1570	1570	115	1362
1144	559	3162	1565	205	2025

SMOKE STOP CIGARETTE BUTT CANS

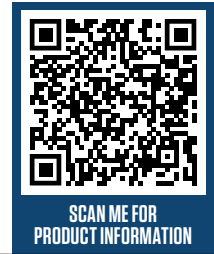

SMOKE STOPS KEEP AREAS CLEAR OF CIGARETTE BUTTS

- Used in factory/office entrances, break areas
 - Construction sites
 - Poolsides
 - Fishing Piers and boat ramps
 - Golf Courses
- Sports Fields
 - Polyethylene construction will not rust or corrode
 - Design minimises smoke exit and water entry
 - Large capacity up to 15 litres, steel pail holds over 3000 cigarette butts, easily removed, cleaned and replaced.



1533

SMOKE STOP CLASSIC GREY

OVER-PACK DRUMS

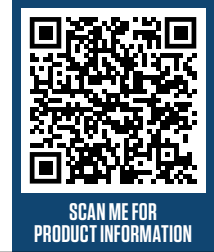

SAVE VALUABLE FLOOR SPACE

- Polyethylene construction will not rust or corrode
- Convenient no tools required closure application is perfect for clean up and spill response activities.



580

OVER-PACK DRUM 360L

P/NO	HEIGHT(MM)	WIDTH(MM)	DEPTH(MM)	WEIGHT(KG)	SUMP(L)
580	1050	830	830	21	360

585

OVER-PACK DRUM 113L



587

OVER-PACK DRUM 76L



P/NO	HEIGHT(MM)	WIDTH(MM)	DEPTH(MM)	WEIGHT(KG)	SUMP(L)
585	765	581	581	7	114
587	483	552	552	5.5	76

UNLIMITED SUPPORT VIA OUR **PRATT HOTLINE**

MANAGED BY OUR EXPERIENCED PRATT TEAM WHO DELIVER:



SERVICE EXCELLENCE

EMERGENCY SHOWER UNITS, EYEWASH UNITS, DANGEROUS GOODS CABINETS, SPILL KITS, GAS & AEROSOL CAGES, SPILL CONTAINMENT



EXPERTISE

TO FIND SOLUTIONS FOR ANY OF OUR CUSTOMERS NEEDS

70+

YEARS EXPERIENCE & KNOWLEDGE

SUPPLYING INDUSTRY, PIONEERS OF EMERGENCY SHOWERS IN AUS

6+

DISTRIBUTION HUBS

AUSTRALIA & NEW ZEALAND FOR FLOOR TO STORE FAST DELIVERY

25+

SALES REPRESENTATIVES

UP-SKILLING YOUR TEAM AND CONNECTING END USERS WITH DISTRIBUTORS ACROSS AUSTRALIA & NEW ZEALAND



RESOURCE LIBRARY

- **AUDIT CHECKLISTS**
- **BEST PRACTICE RECOMMENDATIONS**
- **RISK ANALYSIS**
- **EDUCATIONAL WHITE PAPERS**



Global Provider of Innovative Safety

PIP Global Safety is the world's fastest growing global supplier of personal protective equipment and industrial safety products. With over 40 years of safety expertise, industry-leading brands, quality products and best-in-class customer service, we're committed to being your trusted business partner.

Each day we seek to develop, train and provide our customers with innovative safety products that help keep workers safer, more comfortable and more productive. We work with our distributor partners to deliver best-in-class customer experiences by providing a comprehensive product offering, world-class sales tools and efficient processes.

Our strategically positioned manufacturing facilities around the world enable us to provide safety solutions that are tailored to customer needs. These factories work with our team of product managers, specialists and field quality control technicians to ensure the highest level of product performance and secure proprietary technologies that support us being first to market.

Our slogan 'Bringing the Best of the World to you' is not just about products, it is also about knowledge,

our long-standing history of developing innovative solutions that protect end-users and our commitment to serving our customers better than anyone else in the market. We are here to support you by solving problems in a cost-effective way, and to keep workers safe and performing at their best.

PIP Global Safety recently acquired Paramount Safety Products and Bisley Workwear to secure best-in-class representation in the APAC region.

PIPGLOBAL.COM //////////////////////////////////////

of y Products

EXTENSIVE PRODUCT PORTFOLIO



HAND PROTECTION



PROTECTIVE CLOTHING & WORK WEAR



ARM PROTECTION



HEAD PROTECTION



CHEMICAL & LIQUID PROTECTION



RESPIRATORY PROTECTION



HEARING PROTECTION

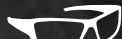

EYE & FACE PROTECTION



RUBBER FOOTWEAR & WORK BOOTS



ERGONOMIC PRODUCTS



HEAT PROTECTION & SUNSCREEN



COLD PROTECTION



HEIGHT SAFETY



LIFTING RIGGING



SITE SAFETY & SPILL CONTROL



SAFETY KNIVES



HYDRATION & COOLING



FIRST AID & INJURY RESPONSE

OUR BRANDS (APAC)

Bisley
WORKWEAR

PRO
PRO CHOICE SAFETY GEAR

THORZT
HYDRATING HARD WORK

G-Tek



PRATT
SAFETY SYSTEMS

PIP



MEDIQ
THE SMART CHOICE IN FIRST AID

Grippaz
Patented Non-Slip Gloves

PUMA
SAFETY



LONG HISTORY OF 35+
YEARS IN PERSONAL PROTECTION



WORKFORCE OF OVER 1700+
DEDICATED AND INSPIRING EMPLOYEES



WIDE SELECTION OF 20,000+
PRODUCTS AND STYLES AVAILABLE



20+ GLOBAL
LOCATIONS



10 MANUFACTURING
LOCATIONS WORLDWIDE



2 MILLION
SQ. FEET OF DISTRIBUTION CENTERS



SUPPORTED BY 12K
HAPPY CUSTOMERS



\$1 BILLION
IN ANNUAL GROSS REVENUE

AUSTRALIA

PHONE: 1300 133 226
EMAIL: INFO@PRATTSAFETY.COM
WEBSITE: PRATTSAFETY.COM.AU

NEW ZEALAND

PHONE: 0800 888 778
EMAIL: INFO@PRATTSAFETY.COM
WEBSITE: PRATTSAFETY.CO.NZ